



Bainbridge

**SAIL & COVER
HARDWARE**

BA2

Contents

Sailman 3000, 3500, 4000 & Battens		6-12
Ubi Maior Batten Box Luff Receptacles		13-14
Battens	Aquabattens	15-24
	Untapered	25-26
	Batten Endcaps	27
Batten Fixings	Pocket Protectors	28
	End Fittings	29
	SDA Fittings	30
Hardware	Track Slides	31-33
	Shackles	34
	Hanks & Tack Fittings	35-36
	Snap Hooks	37
	Blocks	37-38
	Snap Shackles & Fids	39-42
	Halyard Shackles & Dog Bones	43-45
Headboards & Clewboards		46-52
Cleats	Gransegel Cleats & Regular Cleats	53
Clamcleats®		54-62
Luff Tape		64-67
Sailcloth Tapes		68-71
Nicopress Sleeves & Thimbles		72
Pressed Rings	Sailman Rings	73
	Inox Rings	74-75
Stainless Steel Rings		76-77
Patch Cloth		78-80
Insignia	Stripe, Patches, Class Insignia, Numbers and Letters	81-87
Nylon Repair Tape		84
Bag Cloth		87
Ropes & Shockcord		88-92
Shockcord Fittings		93
Grommets & Tools		94-97
Webbing and Fittings		98-102
Seaming & Bonding Tapes		104-105
Seaming Tools		106

Zips	YKK Continuous Vislon®, Vislon® Jacket & Continuous Coil	107-110
Hook & Loop	Catchy & Velcro®	111-113
Thread	Heminway & Bartlett, Coats®, Dabond®, SunStop, SolarFix® & Serabond	114-120
Binding Tapes	Solacryl & Stamoid®	12 -122
Stainless Steel Boat Top Fittings	Eye Ends, End Plugs, Ball Eye Ends, Jaw Slides & Tube Clamps	122-124
Canopy Deck Fittings	Slide Tracks, Deck Hinges & Deck Mounts	125-126
Tube Bending	Bendarc & Crown Arc	127
Awning & Sprayhood Track		128
Keder Tapes & Super Seal		129
Boat Top Fittings	Boat Vents & Awning Poles	130-131
Snap Fasteners	Bainbridge Snaps, YKK® SNAD®, DOT® Button Snaps, Bainbridge Turnbuttons, Permalock, DOT® Commonsense & LOXX	132-144
Cover Making Accessories	Lacing Buttons, Cover Hooks, Eye Straps & Fairlead Eyelets	145
Sewing Machine Needles		146-148
Hand Sewing Needles		149-150
Sewing Palms		151
Repair Kits		152
Thread Lubricant		152
Hot Knives & Blades		153
Thread Snips, Shears & Scissors		154-155
Knives & Blades		156-157
Tools	Cloth Clamps, Awls, Staples, Seaming Tools, Punches, Leather Hammers, Measuring & Marking Tools	158-161
Chemicals, Cleaners & Protectors	Adhesive, Lubricants, Seam Sealers, Cleaners, Polish & Mildew Remover	162-166

Bainbridge Services	168-169
Part No. Index	170-174
Product Index	175-178

Cutting Service

Fully vacuumed, flat 11.0m long x 2.7m wide, multi-tool cutting including pizza wheel, tangent knife, plotting tool heads, and PatternSmith software for in-house design, digitising, and nesting capabilities.

Industries: Combining our vastly experienced team with a state of the art cutting machine allows us to cut a wide range of materials for customers across a variety of industries, including but not limited to:

- Sailmaking
- Covermaking
- Graphics
- Automotive
- Upholstery
- Packaging
- Medical
- Defence
- Tent and marquee
- Inflatable structure
- Flooring
- Outdoor equipment

Bainbridge Cutting Service (BCS) offers you:

- Increased capacity and output
- The opportunity to meet spikes in demand and large one-off orders
- A streamlined production process
- Maximised material yield
- Significantly reduced waste
- A clean consistent cut

Materials: Our Blackman & White automated cutting machine provides a perfect cut across a wide variety of materials, including but not limited to:

- Woven Sailcloth
- Laminates
- Vinyl upholstery fabrics
- Composites
- Vinyl
- Spinnaker nylons
- Cover acrylics and polyesters
- PVC textiles
- Cardboard
- Hypalon



Marketing Support

Bainbridge International has always recognised that as a trade supplier our success is dependent on the success of our customers. With this in mind, Bainbridge continues to update and evolve the marketing support it offers. This ranges from a comprehensive leaflet and sample system to websites dedicated to both the trade and helping the end user understand that specifying Bainbridge products is an investment in performance and value.





Sailman 3000 is a compact integrated full batten system for boats up to 35ft. The system comprises seven profiles of slide linkage that is compatible with Series 25 and Series 35 batten boxes. Sailman 3000 is compatible with most modern internal mast tracks and despite being designed to be affordable, still includes many detailed design features and advanced quality materials.

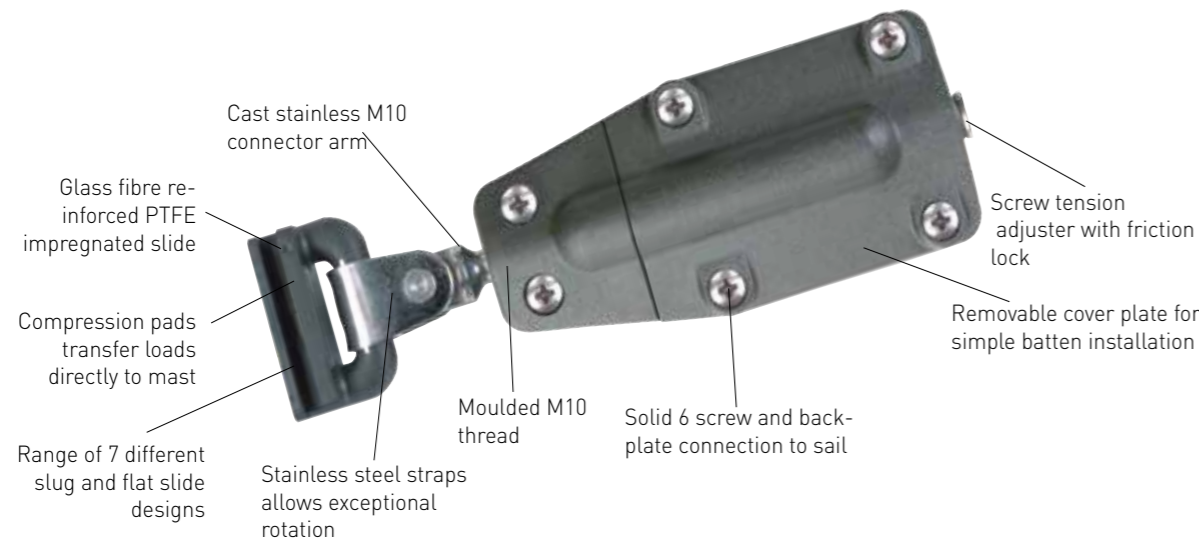

Series 25 (U01540) Luff Box Shown

Part No.	Description	Width mm	Waist mm	Length mm	Connection	Weight g	Battens	Pack Qty / UOM
SLIDES								
A116	Low friction slide	7.5	4	45	U00642/A035BK/ Webbing	12	-	10
A117	Low friction slide	8.5	4	45	U00642/A035BK/ Webbing	13	-	10
A118	Low friction slide	11.5	4	45	U00642/A035BK/ Webbing	15	-	10
A114	Low friction slide Selden 'E' series	15.5	4.4	45	U00642/A035BK/ Webbing	14	-	10
A107	Low friction slide	15.8	7	45	U00642/A035BK/ Webbing	13	-	10
A108	Low friction slide	19.0	9	45	U00642/A035BK/ Webbing	14	-	10
A109	Low friction slide	22	11	45	U00642/A035BK/ Webbing	16	-	10
CONNECTORS								
A035BK	Long reach screw-on shackle	-	-	61	-	-	-	10
U00642	Slide linkage M10	-	-	-	M10 Thread	50	-	Each
LUFF BOXES								
U01540	Series 25 Standard Luff Box with Batten Tension Adjuster	50	-	104	M10 Thread	122	A,B,C,D	Each
U01530	Series 35 Standard Luff Box	62	-	120	M10 Thread	209	A,B,C,D,E,J,K,L	Each
U01531	Series 35 Luff Box with Batten Tension Adjuster	62	-	120	M10 Thread	234	A,B,C,D,E,J,K,L	Each
U01532	Series 35 Batten Box Adjustable	62	-	120	M12 Thread	245	A,B,C,D,E,J,K,L	Each
U01535	Series 35 HD Luff Box with Batten Tension Adjuster	62	-	120	M10 Thread	267	All Battens	Each
U01536	Series 35 HD Batten Box Adjustable	62	-	120	M10 Thread	275	All Battens	Each



- A116 Low friction slide 7.5mm diameter
- A117 Low friction slide 8.5mm diameter
- A118 Low friction slide 11.5mm diameter
- A114 Low friction slide Selden 'E' Series 15.5mm wide
- A107 Low friction slide 15.8mm width
- A108 Low friction slide 19mm width
- A109 Low friction slide 22mm width

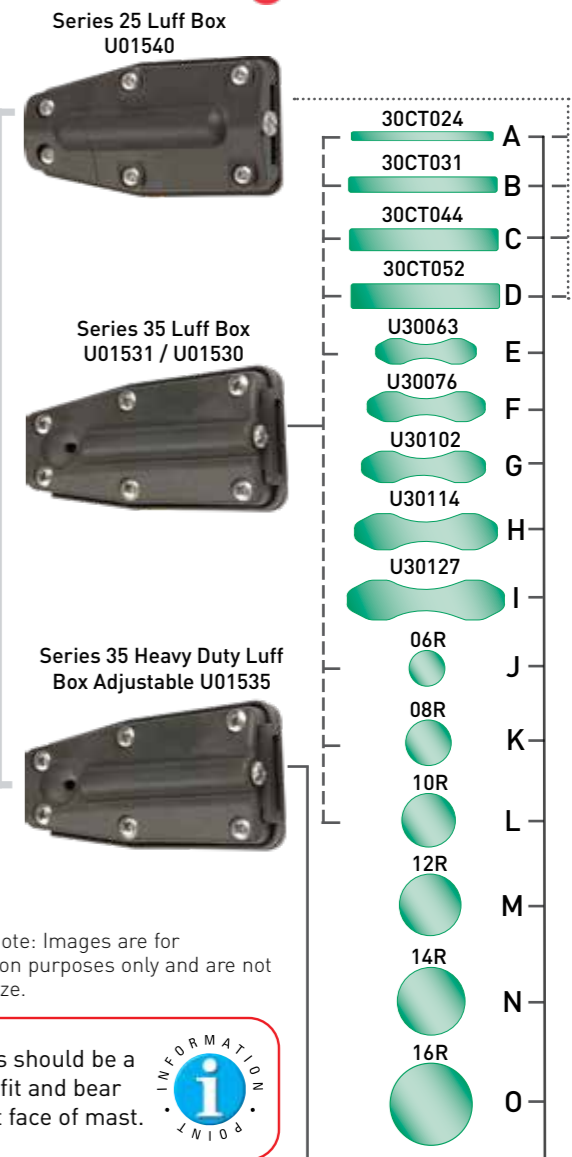
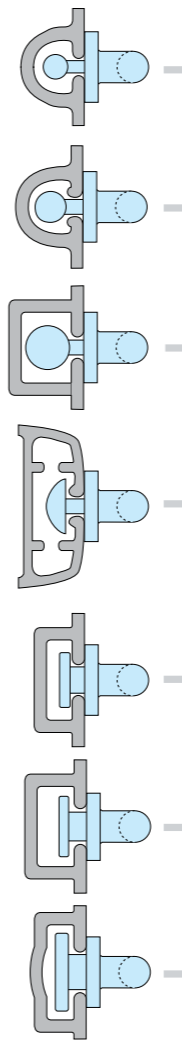

Please note: Images are for illustration purposes only and are not actual size.

Slides should be a snug fit and bear on aft face of mast. 

1 Batten Slides:

- ◆ Seven profiles to fit most modern spars
- ◆ Precision moulded from glass fibre reinforced plastic with a PTFE impregnation
- ◆ Integral compression pad transfers load directly onto aft face of spar
- ◆ Slides can also be used as intermediates using A035BK long reach shackle
- ◆ All slides measure: 45mm or 1 3/4 inches in length
- ◆ Consistent slide + linkage offset for accurate luff curve

2 M10 Side Linkage - U00642:

- ◆ Pressure formed 316 stainless steel double toggle transfers compression directly and evenly on to the slide
- ◆ M10 thread allows connection to Series 25, Series 35 and most other brands of batten box
- ◆ Hinge system allows for 'lay-flat' rotation of battens when the sail is stowed and reefed
- ◆ Clevis pin with heavy duty split ring provides simple sail removal

3 Long Reach Screw-On Shackle - A035BK:

- ◆ Specifically designed for connecting our regular 7 Allslip slides to full batten sails, including those equipped with Sailman 3000, 3500 and 4000 systems

Sail Areas - Recommended maximum sail areas according to yacht type and roach variation:

- **Multihull/Extreme** Maxi roach boats from 22 to 28ft. Up to 25sq metres (269sq feet)
- **Racer/Cruiser** Boats from 22 to 32ft. Up to 30sq metres (323sq feet)
- **Conventional Sloop** Boats from 22 to 35ft. Up to 35sq metres (377sq feet)

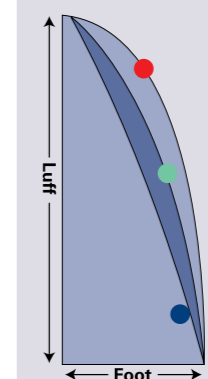

The big-roached rigs of some multihulls and water-ballasted yachts add considerably to the loads applied to batten systems. If in doubt contact Bainbridge International for further advice.



The Sailman 3500 system is designed for boats up to 35ft. It has been specifically designed to fit a full batten sail on three of the most difficult types of spars:

- ◆ Alloy spars with sail feeding gates that are proud of the aft face of the mast
- ◆ Composite spars
- ◆ Alloy and composite wing masts

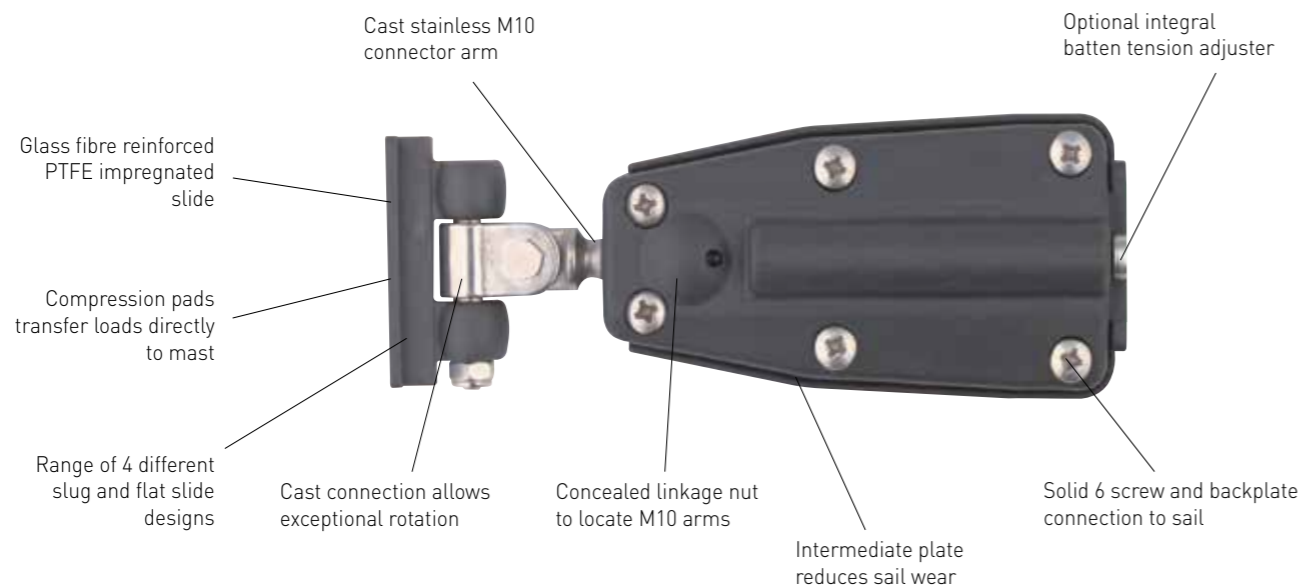

Series 35 (U01531) luff box shown

Part No.	Description	Width mm	Waist mm	Length mm	Connection	Weight g	Battens	UOM
INTERMEDIATE SLIDES								
U00377	Intermediate/Head	9	3.4	55.0	Webbing	30	-	Each
U00361	Intermediate/Head Slide	15.5	7.3	55.0	Webbing	30	-	Each
U00363	Intermediate/Head Slide	17.9	8.7	55.0	Webbing	31	-	Each
U00365	Intermediate/Head Slide	21.5	10.3	55.0	Webbing	34	-	Each
BATTEN SLIDES								
U00357S	Batten Slide Series 35 Luff Box	9	3.4	-	M10 Thread	80	-	Each
U00341S	Batten Slide Series 35 Luff Box	15.5	7.3	55.0	M10 Thread	81	-	Each
U00343S	Batten Slide Series 35 Luff Box	17.9	8.7	55.0	M10 Thread	81	-	Each
U00345S	Batten Slide Series 35 Luff Box	21.5	10.3	55.0	M10 Thread	84	-	Each
CONNECTORS								
U00658	M10 Arm Universal Toggle Assembly	-	-	-	M10 Thread	52	-	Each
LUFF BOXES								
U01540	Series 25 Standard Luff Box with Batten Tension Adjuster	50	-	104	M10 Thread	122	A,B,C,D	Each
U01530	Series 35 Standard Luff Box	62	-	120	M10 Thread	209	A,B,C,D,E,J,K,L	Each
U01531	Series 35 Luff Box with Batten Tension Adjuster	62	-	120	M10 Thread	234	A,B,C,D,E,J,K,L	Each
U01532	Series 35 Batten Box Adjustable	62	-	120	M12 Thread	245	A,B,C,D,E,J,K,L	Each
U01535	Series 35 HD Luff Box with Batten Tension Adjuster	62	-	120	M10 Thread	267	All Battens	Each
U01536	Series 35 HD Batten Box Adjustable	62	-	120	M12 Thread	275	All Battens	Each

U00357S M10 Arm
U00377 Intermediate



U00341S M10 Arm
U00361 Intermediate



U00343S M10 Arm
U00363 Intermediate



U00345S M10 Arm
U00365 Intermediate

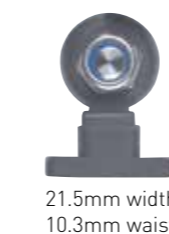

1 Intermediate Slide



1 M10 Batten Slide



U00658



Series 25 Luff Box
U01540



Series 35 Luff Box
U01531 / U01530



Series 35 Heavy Duty Luff Box
Adjustable U01535

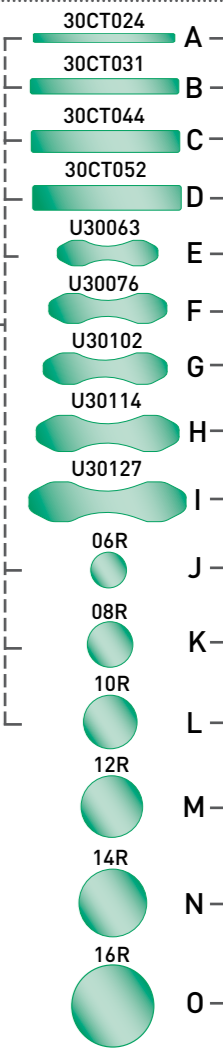

Please note: Images are for illustration purposes only and are not actual size.

Slides should be a snug fit and bear on aft face of mast.

1 Batten Slides:

- ◆ Sailman 3500 slides are designed to run inside the mast groove and unlike Sailman 3000 and 4000 slides, do not bear on the aft face of the mast. This allows them to run past feeding gates and to slide in very narrow grooves on composite wing masts
- ◆ To prevent wear on composite spars the sliders have no exposed metal parts
- ◆ The smallest slug version has a waist of just 3.4mm, allowing it to fit the narrowest of grooves
- ◆ Glass reinforced and PTFE impregnated construction
- ◆ Fully articulating solid stainless steel joint allows 'lay-flat' rotation of battens when sail is stowed or reefed
- ◆ M10 thread allows connection to Series 25, Series 35, Series 55 and most other brands of batten box
- ◆ Cotton reel on intermediate slides for easy sail removal and to reduce wear
- ◆ Consistent slide + linkage offset for accurate luff curve

Sail Areas - Recommended maximum sail areas according to yacht type and roach variation:

- **Multihull/Extreme Maxi** roach boats from 22 to 28ft. Up to 25sq metres (269sq ft)
- **Racer/Cruiser** Boats from 22 to 32ft. Up to 30sq metres (323sq ft)
- **Conventional Sloop** Boats from 22 to 35ft. Up to 35sq metres (377sq ft)

The big-roached rigs of some multihulls and water-ballasted yachts add considerably to the loads applied to batten systems. If in doubt contact Bainbridge International for further advice.



sailman 4000

Sailman 4000 is a premium trackless full batten system for boats up to 43ft. The system comprises seven profiles of slides that feature a durable hinge system and stainless steel reinforced slugs. All slides are compatible with Series 35 and Series 55 batten boxes. Sailman 4000 has been designed as a premium system that, through careful design and detailed engineering, delivers excellent performance and strength without the complication and cost of fitting an external track.

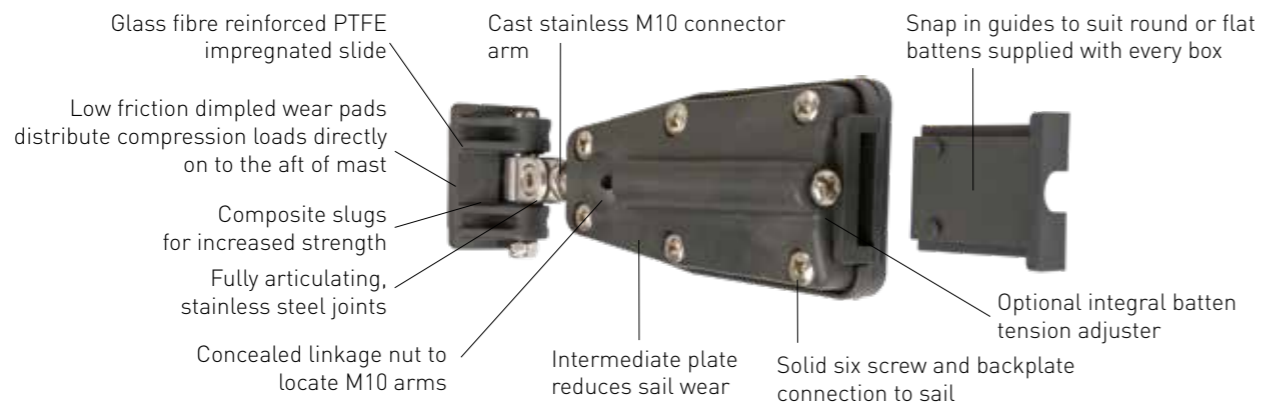

Series 35 (U01531) Luff Box Shown

Part No.	Description	Width mm	Waist mm	Length mm	Connection	Weight g	Battens	UOM
INTERMEDIATE SLIDES								
U00472	Intermediate/Head Slide	10	3.6	52	Webbing	64	-	Each
U00474	Intermediate/Head Slide	11	3.7	52	Webbing	63	-	Each
U00462	Intermediate/Head Slide	16.3	8.5	52	Webbing	61	-	Each
U00463	Intermediate/Head Slide Selden 'C'	16.3	9.4	52	Webbing	68	-	Each
U00464	Intermediate/Head Slide	18.8	4.7	52	Webbing	65	-	Each
U00466	Intermediate/Head Slide	23	12	52	Webbing	68	-	Each
U00468	Intermediate/Head Slide	24	12	52	Webbing	68	-	Each
U00322	Spare Cotton Reel for Intermediate Sliders	-	-	-	Webbing	-	-	Each
BATTEN SLIDES M10 ARM INCLUDED								
U00452S	Batten Side	10	3.6	52	M10 Thread	113	-	Each
U00454S	Batten Side	11	3.7	52	M10 Thread	112	-	Each
U00442S	Batten Slide	16.3	8.5	52	M10 Thread	112	-	Each
U00443S	Batten Slide Selden 'C'	16.3	9.4	52	M10 Thread	118	-	Each
U00444S	Batten Slide	18.8	4.7	52	M10 Thread	112	-	Each
U00446S	Batten Slide	23	12	52	M10 Thread	118	-	Each
U00448S	Batten Slide	24	12	52	M10 Thread	117	-	Each
CONNECTORS								
U00658	M10 Arm Universal Toggle Assembly	-	-	-	M10 Thread	52	-	Each
LUFF BOXES								
U01530	Series 35 Standard Luff Box	62	-	120	M10 Thread	209	A,B,C,D,E,J,K,L	Each
U01531	Series 35 Luff Box with Batten Tension Adjuster	62	-	120	M10 Thread	234	A,B,C,D,E,J,K,L	Each
U01532	Series 35 Batten Box Adjustable	62	-	120	M12 Thread	245	A,B,C,D,E,J,K,L	Each
U01535	Series 35 HD Luff Box with Batten Tension Adjuster	62	-	120	M10 Thread	267	All Battens	Each
U01536	Series 35 HD Batten Box Adjustable	62	-	120	M12 Thread	275	All Battens	Each
U01520Y	Series 55 Luff Box with Batten Tension Adjuster	73	-	127	M10 Thread	275	A,B,C,D,E,F,G,J,K,L,M	Each

sailman 4000

U00472 Intermediate
U00452S M10
U00472H 10mm headslide

U00474 Intermediate
U00454S M10
U00474H 11mm headslide

U00462 Intermediate
U00442S M10
U00462H 16.3mm headslide

U00463 Intermediate
U00443S M10
U00463H 16.3mm headslide

U00464 Intermediate
U00444S M10
U00464H 18.8mm headslide

U00466 Intermediate
U00446S M10
U00466H 23mm headslide

U00468 Intermediate
U00448S M10
U00468H 24mm headslide

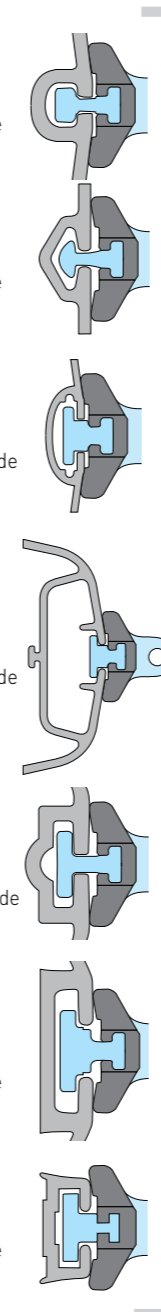

1 M10 Batten Slide

2 Intermediate Slide



Series 35 Luff Box
U01531 / U01530



Series 35 Heavy Duty Luff Box Adjustable U01535



Series 55 Luff Box
U01520Y

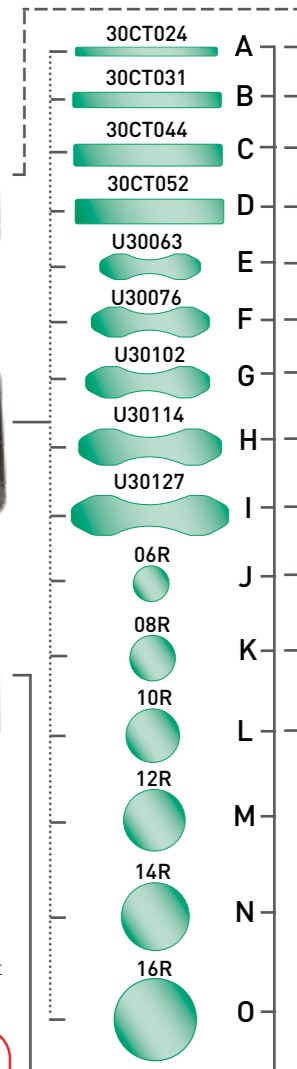

Please note: Images are for illustration purposes only and are not actual size.

Slides should be a snug fit and bear on aft face of mast. 

1 Batten Slides:

- ◆ Seven profiles to fit most modern spars
- ◆ Precision moulded from glass fibre reinforced plastic with PTFE impregnation
- ◆ Durable stainless steel hinge system and connecting arm
- ◆ Low friction compression pads transfer load directly onto aft face of spar
- ◆ Composite slugs with stainless steel reinforced for extra strength
- ◆ Consistent slide + linkage offset for accurate luff curve

2 Intermediate Slide:

- ◆ Moulded cotton reels for web on attachment in intermediate positions
- ◆ Can also be webbed to SailmanX headboards as light duty headslides

Sail Areas - Recommended maximum sail areas according to yacht type and roach variation:

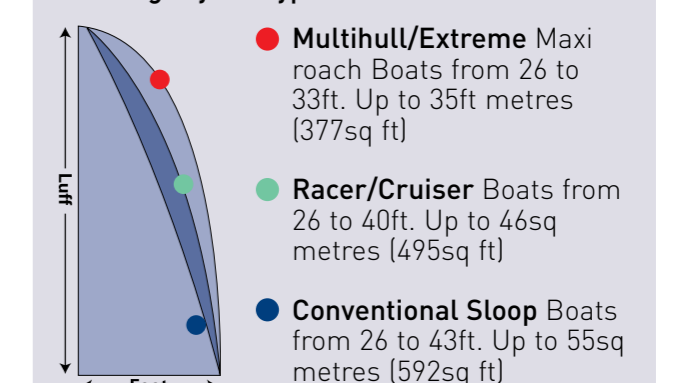

The big-roached rigs of some multihulls and water-ballasted yachts add considerably to the loads applied to batten systems. If in doubt contact Bainbridge International for further advice.



See page 27 for Batten End Caps
See page 26 for Rod Batten Connectors

Flat Battens

- ◆ These low cost, quality pultrusions are tough and durable. The use of battens can help minimise sail wear. All styles are 30mm wide but vary in thickness to offer logical and progressive increases in stiffness. This allows different stiffnesses to use the same width pocket and luff box



Part No.	Luff Box	Profile	Width mm	Thickness mm	EI (NM2)	Weight g	Length m
30CT024	U01540 U01530/31/32 U01535/36 U01520Y	Flat	30	2.4	1.1	145	6
30CT031	U01540 U01530/31/32 U01535/36 U01520Y	Flat	30	3.1	2.3	188	6
30CT044	U01540 U01531/30 U01535 U01520Y	Flat	30	4.4	7.1	266	6
30CT052	U01540 U01531/30 U01535 U01520Y	Flat	30	5.2	12.7	315	6
Flat Battens - Long Reels							
30CT024R	U01540 U01530/31/32 U01535/36 U01520Y	Flat	30	2.4	1.1	145	30
30CT031R	U01540 U01530/31/32 U01535/36 U01520Y	Flat	30	3.1	2.3	188	30
30CT044R	U01540 U01531/30 U01535 U01520Y	Flat	30	4.4	7.1	266	30
30CT052R	U01540 U01531/30 U01535 U01520Y	Flat	30	5.2	12.7	315	30

Sailman Battens

- ◆ Highest quality vinylester pultrusions deliver ultimate tenacity for demanding full batten applications
- ◆ They feature a logical and progressive range of stiffnesses and a common 30mm width



Part No.	Luff Box	Profile	Width mm	Thickness mm	EI (NM2)	Weight g	Length m
U30063	U01530/31 32 U01535/36 U01520Y	Sailman	30	6.3	23.3	293	12
U30076	U01535/36 U01520Y	Sailman	30	7.6	40.4	382	12
U30102	U01535/36 U01520Y	Sailman	30	10.2	101.6	530	12
U30114	U01535/36	Sailman	30	11.4	136.8	618	12
U30127	U01535/36	Sailman	30	12.7	199.3	704	12

Round Battens

- ◆ Outstanding stiffness to weight combined with low cost make round section pultrusions an excellent choice for full batten applications



Part No.	Luff Box	Profile	Width mm	Thickness mm	EI (NM2)	Weight g	Length m
06R	U01530 U01535/36 U01520Y	Rod	6	6	3.3	52	6
08R	U01530 U01535/36 U01520Y	Rod	6	8	11.2	88	6
10R	U01530 U01535/36 U01520Y	Rod	10	10	25.8	114	6
12R	U01535/36 U01520Y	Rod	12	12	53.6	211	6
14R	U01535/36	Rod	14	14	99.2	286	6
16R	U01535/36	Rod	16	16	169	364	6
Round Battens - Long Reels							
06R30	U01530 U01535/36 U01520Y	Rod	6	6	3.3	52	30
08R30	U01530 U01535/36 U01520Y	Rod	6	8	11.2	88	30
10R30	U01530 U01535/36 U01520Y	Rod	10	10	25.8	114	30



Batten Box Luff Receptacles

- ◆ Designed to be lightweight and strong
- ◆ Machined in aluminum 6082T6 and anodized
- ◆ These fixtures allow batten tension to be adjusted on deck or while sailing
- ◆ Available in 3 dimensions (PS50 for boats of +/- 50 feet, PS70 for 70 feet and PS100 for boats over 100 feet)

Non Adjustable Batten Boxes

Round Batten

Part No.	Indicative Boat Length: m / ft	Batten Type	Box Dims: mm	Material	Threaded Fitting	Weight g	UOM
UBPS70NM10	21 / 70	Round	Ø24	Aluminium	M10	280	Each
UBPS70NM12	21 / 70	Round	Ø24	Aluminium	M12	280	Each
UBPS70NM14	21 / 70	Round	Ø24	Aluminium	M14	280	Each



Flat Batten

Part No.	Indicative Boat Length: m / ft	Batten Type	Box Dims: mm	Material	Threaded Fitting	Weight g	UOM
UBPS70PNM10	21 / 70	Flat	30 x 16	Delrin	M10	350	Each
UBPS70PNM12	21 / 70	Flat	30 x 16	Delrin	M12	350	Each
UBPS70PNM14	21 / 70	Flat	30 x 16	Delrin	M14	350	Each
UBPS100PNM12	30 / 100	Flat	42 x 22	Delrin	M12	810	Each
UBPS100PNM14	30 / 100	Flat	42 x 22	Delrin	M14	810	Each
UBPS100PNM16	30 / 100	Flat	42 x 22	Delrin	M16	810	Each



Adjustable Batten Boxes

Round Batten

Part No.	Indicative Boat Length: m / ft	Batten Type	Box Dims: mm	Material	Threaded Fitting	Weight g	UOM
UBPS70T20M10	21 / 70	Round	Ø20	Aluminium	M10	480	Each
UBPS70T20M12	21 / 70	Round	Ø20	Aluminium	M12	480	Each
UBPS70T24M10	21 / 70	Round	Ø24	Aluminium	M10	480	Each
UBPS70T24M12	21 / 70	Round	Ø24	Aluminium	M12	480	Each



Flat Batten

Part No.	Indicative Boat Length: m / ft	Batten Type	Box Dims: mm	Material	Threaded Fitting	Weight g	UOM
UBPS40PM10	12 / 40	Flat	22 x 11	Nylon / Aluminium	M8	110	Each



Flat Batten

Part No.	Indicative Boat Length: m / ft	Batten Type	Box Dims: mm	Material	Threaded Fitting	Weight g	UOM
UBPS50M10	15 / 50	Flat	33 x 12	Aluminium	M10	240	Each
UBPS50M12	15 / 50	Flat	33 x 12	Aluminium	M12	240	Each

Flat Batten

Part No.	Indicative Boat Length: m / ft	Batten Type	Box Dims: mm	Material	Threaded Fitting	Weight g	UOM
UBPS70PM10	21 / 70	Flat	31 x 13	Aluminium	M10	480	Each
UBPS70PM12	21 / 70	Flat	31 x 13	Aluminium	M12	480	Each
UBPS100PM12	30 / 100	Flat	38 x 21	Aluminium	M12	1000	Each
UBPS100PM14	30 / 100	Flat	39 x 21	Aluminium	M14	1000	Each
UBPS100PM16	30 / 100	Flat	40 x 21	Aluminium	M16	1000	Each



Aquabatten delivers finer tips with thicker ends - resulting in maximum force and strength through the batten length.

- ◆ Unique layering process reduces the risk of inter-laminar bond failure
- ◆ No filaments cut in tapering process - unique laminate construction encapsulated in a multi-layer outer casing
- ◆ Minimised batten failure, reduces replacement costs
- ◆ Construction reduces stress - maximum stress is dissipated along the batten
- ◆ Epoxy resin composition gives a stronger, hydrophobic batten which keeps the batten at design weight and eliminates loss of strength in the resin

By manufacturing the product in an advanced bi-directional scrim lay-up, Aquabatten uses up to 56 laminations which are totally encapsulated; ensuring the inherent strength of the construction is not ground away - which is the case with most other tapered battens. This ensures greater structural integrity, strength and durability.

Today, **Aquabatten** has been developed to offer the most comprehensive range of widths, lengths and types - designed to suit the very latest sail designs and to continue to offer the very best performance.

Definition of EI:

EI is an expression of the 'Flexural Rigidity' of a bar - equal to the resistance offered by a structure while undergoing bending.

Understanding EI:

E = The stiffness of the material (Young Modulus), **I** = The stiffness of the shape (form) itself.

Therefore **EI** is the combination of the material and the shape. In combining the two together (**EI**) it delivers a 'common comparator' which allows you to technically specify the correct batten for that particular part of the sail construction.

The higher the **EI**, the stiffer the batten will be. By using **EI** a sailmaker has the flexibility of reducing the width of a batten by increasing the thickness, this enables lighter battens to be specified in the sail design - resulting in a lower weight sail delivering improved performance.

In line with market leading sail design

software which utilises FEA (Flexible Element Analysis).

Aquabatten Pod

- Stock up on Bainbridge Aquabattens and receive a **New Pod free of charge!***
- Holds over 100 battens
- The professional way to present battens for point of sale or loft storage
- Easily replenished, with large stocks available for same day despatch

The Battens

- Aquabatten, market leading sail battens for yacht and dinghy
- Glass epoxy and carbon epoxy
- Easy-to-use batten selection app
- Designed and made in the UK

*Free Pod requires minimum order value. Terms & Conditions apply

Part no.	Explanation
L4 04 080 G 15	
L	L = Laminated Aquabatten
4	4 = 40% taper. 2 for 20% taper
04	04 = 4mm thick
080	080 = 800mm long
G	G = Glass Epoxy. "C" for Carbon Epoxy
15	15 = 15mm wide



UBI MAIOR
ITALIA

FULL RANGE OF SAIL BLOCKS, DECK HARWARE & FURLERS















The full range of Ubi Maior products are available from bainbridgeint.com





- ◆ PRE-PREG GLASS EPOXY untapered batten range
- ◆ Unique layering process increases inter-laminar bond
- ◆ Laminate construction encapsulated in a multi layer outer casing minimises batten failure
- ◆ Stress is dissipated along the full length of the batten
- ◆ Handles torque stress caused by twist, where uni-directional pultruded battens can fail

L0 Glass Epoxy

Uniform 10mm Battens

Part No.	Stiffness	Width mm	Thickness mm	EI Number	Length cm	UOM
EXTRA SOFT						
L001200G10	Extra Soft	10	1 x 1	0.02	200	Each
L001240G10	Extra Soft	10	1 x 1	0.02	240	Each
L0016200G10	Extra Soft	10	1.6 x 1.6	0.15	200	Each
L0016240G10	Extra Soft	10	1.6 x 1.6	0.15	240	Each
L002100G10	Extra Soft	10	2 x 2	0.2	100	Each
L002120G10	Extra Soft	10	2 x 2	0.2	120	Each
L002200G10	Extra Soft	10	2 x 2	0.2	200	Each
L002240G10	Extra Soft	10	2 x 2	0.2	240	Each
L003100G10	Extra Soft	10	3 x 3	0.7	100	Each
L003120G10	Extra Soft	10	3 x 3	0.7	120	Each
L003200G10	Extra Soft	10	3 x 3	0.7	200	Each
L003240G10	Extra Soft	10	3 x 3	0.7	240	Each
SOFT						
L004120G10	Soft	10	4 x 4	1.5	120	Each
L004140G10	Soft	10	4 x 4	1.5	140	Each
L004240G10	Soft	10	4 x 4	1.5	240	Each
L005240G10	Soft	10	5 x 5	3	240	Each
MEDIUM						
L006240G10	Medium	10	6 x 6	5	240	Each

Uniform 15mm Battens

Part No.	Stiffness	Width mm	Thickness mm	EI Number	Length cm	UOM
EXTRA SOFT						
L001240G15	Extra Soft	15	1 x 1	0.04	240	Each
L0016240G15	Extra Soft	15	1.6 x 1.6	0.2	240	Each
L002240G15	Extra Soft	15	2 x 2	0.3	240	Each
SOFT						
L003120G15	Soft	15	3 x 3	1	120	Each
L003200G15	Soft	15	3 x 3	1	200	Each
L003240G15	Soft	15	3 x 3	1	240	Each
L004120G15	Soft	15	4 x 4	2.3	1200	Each
L004140G15	Soft	15	4 x 4	2.3	140	Each
L004240G15	Soft	15	4 x 4	2.3	240	Each
MEDIUM						
L005240G15	Medium	15	5 x 5	5	240	Each
L006220G15	Medium	15	6 x 6	8	220	Each
L006240G15	Medium	15	6 x 6	8	240	Each

L001200G10  BAINBRIDGE EI 0.2



STIFF						
L007240G15	Stiff	15	7 x 7	12	240	Each
L008240G15	Stiff	15	7 x 7	19	240	Each

Uniform 20mm Battens

Part No.	Stiffness	Width mm	Thickness mm	EI Number	Length cm	UOM
MEDIUM						
L004120G20	Medium	20	4 x 4	3	120	Each
L005240G20	Medium	20	5 x 5	6	240	Each
STIFF						
L006220G20	Stiff	20	6 x 6	10	220	Each
L006240G20	Stiff	20	6 x 6	10	240	Each
L007180G20	Stiff	20	7 x 7	17	180	Each
L007240G20	Stiff	20	7 x 7	17	240	Each
L008240G20	Stiff	20	8 x 8	25	240	Each

L2 Glass Epoxy

Dinghy / One Design 10mm Battens

Part No.	Stiffness	Width mm	Thickness mm	EI Number	Length cm	UOM
EXTRA SOFT						
L202030G10	Extra Soft	10	2 x 1	0.2	30	Each
L202040G10	Extra Soft	10	2 x 1	0.2	40	Each
L202050G10	Extra Soft	10	2 x 1	0.2	50	Each
L202060G10	Extra Soft	10	2 x 1	0.2	60	Each
L202070G10	Extra Soft	10	2 x 1	0.2	70	Each
SOFT						
L203040G10	Soft	10	3 x 1	0.7	40	Each
L203050G10	Soft	10	3 x 1	0.7	50	Each
L203060G10	Soft	10	3 x 1	0.7	60	Each
L203070G10	Soft	10	3 x 1	0.7	70	Each
L203080G10	Soft	10	3 x 1	0.7	80	Each
L203100G10	Soft	10	3 x 1	0.7	100	Each
MEDIUM						
L204060G10	Medium	10	4 x 1	1.5	60	Each
L204070G10	Medium	10	4 x 1	1.5	70	Each
L204080G10	Medium	10	4 x 1	1.5	80	Each
L204100G10	Medium	10	4 x 1	1.5	100	Each
L205080G10	Medium	10	5 x 1	3	80	Each
L205090G10	Medium	10	5 x 1	3	90	Each
L205100G10	Medium	10	5 x 1	3	100	Each
L205120G10	Medium	10	5 x 1	3	120	Each
L205140G10	Medium	10	5 x 1	3	140	Each

L005240G15  BAINBRIDGE EI 5



L4 Glass Epoxy

Yacht 10mm Battens

Part No.	Stiffness	Width mm	Thickness mm	EI Number	Length cm	UOM
SOFT						
L402030G10	Soft	10	2 x 1	0.2	30	Each
L402040G10	Soft	10	2 x 1	0.2	40	Each
L402050G10	Soft	10	2 x 1	0.2	50	Each
L402060G10	Soft	10	2 x 1	0.2	60	Each
L402070G10	Soft	10	2 x 1	0.2	70	Each
L402080G10	Soft	10	2 x 1	0.2	80	Each
L403040G10	Soft	10	3 x 1	0.7	40	Each
L403050G10	Soft	10	3 x 1	0.7	50	Each
L403060G10	Soft	10	3 x 1	0.7	60	Each
L403070G10	Soft	10	3 x 1	0.7	70	Each
L403080G10	Soft	10	3 x 1	0.7	80	Each
L403100G10	Soft	10	3 x 1	0.7	100	Each
MEDIUM						
L404050G10	Medium	10	4 x 1	1.5	50	Each
L404060G10	Medium	10	4 x 1	1.5	60	Each
L404070G10	Medium	10	4 x 1	1.5	70	Each
L404080G10	Medium	10	4 x 1	1.5	80	Each
L404090G10	Medium	10	4 x 1	1.5	90	Each
L404100G10	Medium	10	4 x 1	1.5	100	Each
L404120G10	Medium	10	4 x 1	1.5	120	Each
L404140G10	Medium	10	4 x 1	1.5	140	Each
L405070G10	Medium	10	5 x 1	3	70	Each
L405080G10	Medium	10	5 x 1	3	80	Each
L405090G10	Medium	10	5 x 1	3	90	Each
L405100G10	Medium	10	5 x 1	3	100	Each
L405120G10	Medium	10	5 x 1	3	120	Each
L405140G10	Medium	10	5 x 1	3	140	Each
L405160G10	Medium	10	5 x 1	3	160	Each
L405180G10	Medium	10	5 x 1	3	180	Each
STIFF						
L406100G10	Stiff	10	6 x 1	5	100	Each
L406120G10	Stiff	10	6 x 1	5	120	Each
L406140G10	Stiff	10	6 x 1	5	140	Each
L406160G10	Stiff	10	6 x 1	5	160	Each
L406180G10	Stiff	10	6 x 1	5	180	Each
L406200G10	Stiff	10	6 x 1	5	200	Each

L402030G10



BAINBRIDGE EI 0.2

Yacht 15mm Battens

Part No.	Stiffness	Width mm	Thickness mm	EI Number	Length cm	UOM
SOFT						
L402030G15	Soft	15	2 x 1	0.3	30	Each
L402050G15	Soft	15	2 x 1	0.3	50	Each
L402060G15	Soft	15	2 x 1	0.3	60	Each
L403040G15	Soft	15	3 x 1	1	40	Each
L403050G15	Soft	15	3 x 1	1	50	Each
L403060G15	Soft	15	3 x 1	1	60	Each
L403070G15	Soft	15	3 x 1	1	70	Each
L403080G15	Soft	15	3 x 1	1	80	Each
L403100G15	Soft	15	3 x 1	1	100	Each
L403120G15	Soft	15	3 x 1	1	120	Each
MEDIUM						
L404060G15	Medium	15	4 x 1	2.3	70	Each
L404070G15	Medium	15	4 x 1	2.3	80	Each
L404080G15	Medium	15	4 x 1	2.3	80	Each
L404090G15	Medium	15	4 x 1	2.3	90	Each
L404100G15	Medium	15	4 x 1	2.3	100	Each
L404120G15	Medium	15	4 x 1	2.3	120	Each
L404140G15	Medium	15	4 x 1	2.3	140	Each
L404160G15	Medium	15	4 x 1	2.3	160	Each
L404180G15	Medium	15	4 x 1	2.3	180	Each
L404200G15	Medium	15	4 x 1	2.3	200	Each
L405070G15	Medium	15	5 x 1	5	70	Each
L405080G15	Medium	15	5 x 1	5	80	Each
L405090G15	Medium	15	5 x 1	5	90	Each
L405100G15	Medium	15	5 x 1	5	100	Each
L405120G15	Medium	15	5 x 1	5	120	Each
L405140G15	Medium	15	5 x 1	5	140	Each
L405160G15	Medium	15	5 x 1	5	160	Each
L405180G15	Medium	15	5 x 1	5	180	Each
L405200G15	Medium	15	5 x 1	5	200	Each
L405220G15	Medium	15	5 x 1	5	200	Each
STIFF						
L406080G15	Stiff	15	6 x 1	8	80	Each
L406100G15	Stiff	15	6 x 1	8	100	Each
L406120G15	Stiff	15	6 x 1	8	120	Each
L406140G15	Stiff	15	6 x 1	8	140	Each
L406160G15	Stiff	15	6 x 1	8	160	Each
L406180G15	Stiff	15	6 x 1	8	180	Each
L406200G15	Stiff	15	6 x 1	8	200	Each
L406220G15	Stiff	15	6 x 1	8	220	Each
L406240G15	Stiff	15	6 x 1	8	240	Each
L407100G15	Stiff	15	7 x 1.25	12	100	Each
L407120G15	Stiff	15	7 x 1.25	12	120	Each
L407140G15	Stiff	15	7 x 1.25	12	140	Each
L407160G15	Stiff	15	7 x 1.25	12	160	Each

L4002030G15



BAINBRIDGE EI 0.3

L407180G15	Stiff	15	7 x 1.25	12	180	Each
L407200G15	Stiff	15	7 x 1.25	12	200	Each
L407220G15	Stiff	15	7 x 1.25	12	220	Each
L407240G15	Stiff	15	7 x 1.25	12	240	Each
EXTRA STIFF						
L408100G15	Extra Stiff	15	8 x 1.25	19	100	Each
L408140G15	Extra Stiff	15	8 x 1.25	19	140	Each
L408160G15	Extra Stiff	15	8 x 1.25	19	160	Each
L408180G15	Extra Stiff	15	8 x 1.25	19	180	Each
L408200G15	Extra Stiff	15	8 x 1.25	19	200	Each
L408220G15	Extra Stiff	15	8 x 1.25	19	220	Each
L408240G15	Extra Stiff	15	8 x 1.25	19	240	Each
L408120G15	Extra Stiff	15	8 x 2.5	19	120	Each
L409180G15	Extra Stiff	15	9 x 1.25	26	180	Each

Yacht 20mm Batts

Part No.	Stiffness	Width mm	Thickness mm	EI Number	Length cm	UOM
SOFT						
L403100G20	Soft	20	3 x 1	1.3	100	Each
L404100G20	Soft	20	4 x 1	3	100	Each
L405080G20	Soft	20	5 x 1	6	80	Each
L405100G20	Soft	20	5 x 1	6	100	Each
L405120G20	Soft	20	5 x 1	6	120	Each
L405140G20	Soft	20	5 x 1	6	140	Each
L405160G20	Soft	20	5 x 1	6	160	Each
L405180G20	Soft	20	5 x 1	6	180	Each
MEDIUM						
L406080G20	Medium	20	6 x 1	10	80	Each
L406100G20	Medium	20	6 x 1	10	100	Each
L406120G20	Medium	20	6 x 1	10	120	Each
L406140G20	Medium	20	6 x 1	10	140	Each
L406160G20	Medium	20	6 x 1	10	160	Each
L406180G20	Medium	20	6 x 1	10	180	Each
L406200G20	Medium	20	6 x 1	10	200	Each
L406220G20	Medium	20	6 x 1	10	220	Each
L406240G20	Medium	20	6 x 1	10	240	Each
L407100G20	Medium	20	7 x 1.25	17	100	Each
L407120G20	Medium	20	7 x 1.25	17	120	Each
L407140G20	Medium	20	7 x 1.25	17	140	Each
L407160G20	Medium	20	7 x 1.25	17	160	Each
L407180G20	Medium	20	7 x 1.25	17	180	Each
L407200G20	Medium	20	7 x 1.25	17	200	Each
L407220G20	Medium	20	7 x 1.25	17	220	Each
L407240G20	Medium	20	7 x 1.25	17	240	Each
STIFF - 16.7 to 35.2						
L408100G20	Stiff	20	8 x 1.25	25	100	Each
L408140G20	Stiff	20	8 x 1.25	25	140	Each

L403100G20  BAINBRIDGE EI 1.3

L408160G20	Stiff	20	8 x 1.25	25	160	Each
L408180G20	Stiff	20	8 x 1.25	25	180	Each
L408200G20	Stiff	20	8 x 1.25	25	200	Each
L408220G20	Stiff	20	8 x 1.25	25	220	Each
L408240G20	Stiff	20	8 x 1.25	25	240	Each
L408120G20	Stiff	20	8 x 2.5	25	120	Each
L409140G20	Stiff	20	9 x 1.25	35	140	Each
L409160G20	Stiff	20	9 x 1.25	35	160	Each
L409180G20	Stiff	20	9 x 1.25	35	180	Each
L409200G20	Stiff	20	9 x 1.25	35	200	Each
L409220G20	Stiff	20	9 x 1.25	35	220	Each
L409240G20	Stiff	20	9 x 1.25	35	240	Each
EXTRA STIFF						
L410160G20	Extra Stiff	20	10 x 1.75	48	1600	Each
L410180G20	Extra Stiff	20	10 x 1.75	48	1800	Each
L410200G20	Extra Stiff	20	10 x 1.75	48	2000	Each
L410220G20	Extra Stiff	20	10 x 1.75	48	2200	Each
L410240G20	Extra Stiff	20	10 x 1.75	48	2400	Each
L411200G20	Extra Stiff	20	11 x 1.75	64	2000	Each
L411220G20	Extra Stiff	20	11 x 1.75	64	2200	Each
L411240G20	Extra Stiff	20	11 x 1.75	64	2400	Each
L412220G20	Extra Stiff	20	12 x 2	83	2200	Each
L412240G20	Extra Stiff	20	12 x 2	83	2400	Each

Yacht 25mm Batts

Part No.	Stiffness	Width mm	Thickness mm	EI Number	Length cm	UOM
MEDIUM						
L408200G25	Medium	25	8 x 1.25	31	200	Each
L409120G25	Medium	25	9 x 1.25	44	120	Each
L409140G25	Medium	25	9 x 1.25	44	140	Each
L409160G25	Medium	25	9 x 1.25	44	160	Each
L409180G25	Medium	25	9 x 1.25	44	180	Each
L409200G25	Medium	25	9 x 1.25	44	200	Each
L409220G25	Medium	25	9 x 1.25	44	220	Each
L409240G25	Medium	25	9 x 1.25	44	240	Each
STIFF						
L410100G25	Stiff	25	10 x 1.75	60	100	Each
L410140G25	Stiff	25	10 x 1.75	60	140	Each
L410160G25	Stiff	25	10 x 1.75	60	160	Each
L410180G25	Stiff	25	10 x 1.75	60	180	Each
L410200G25	Stiff	25	10 x 1.75	60	200	Each
L410220G25	Stiff	25	10 x 1.75	60	220	Each
L410240G25	Stiff	25	10 x 1.75	60	240	Each
L411100G25	Stiff	25	11 x 1.75	80	100	Each
L411160G25	Stiff	25	11 x 1.75	80	160	Each
L411180G25	Stiff	25	11 x 1.75	80	180	Each
L411200G25	Stiff	25	11 x 1.75	80	200	Each

L408200G25  BAINBRIDGE EI 31

L411220G25	Stiff	25	11 x 1.75	80	220	Each
L411240G25	Stiff	25	11 x 1.75	80	240	Each
EXTRA STIFF						
L412180G25	Extra Stiff	25	12 x 2	104	180	Each
L412200G25	Extra Stiff	25	12 x 2	104	200	Each
L412220G25	Extra Stiff	25	12 x 2	104	220	Each
L412240G25	Extra Stiff	25	12 x 2	104	240	Each
L413200G25	Extra Stiff	25	13 x 2	133	200	Each
L413220G25	Extra Stiff	25	13 x 2	133	220	Each
L413240G25	Extra Stiff	25	13 x 2	133	240	Each
L414200G25	Extra Stiff	25	14 x 2	166	200	Each
L414220G25	Extra Stiff	25	14 x 2	166	220	Each
L414240G25	Extra Stiff	25	14 x 2	166	240	Each

Yacht 30mm Batts

Part No.	Stiffness	Width mm	Thickness mm	EI Number	Length cm	UOM
EXTRA STIFF						
L406120G30	Extra Stiff	30	6 x 1	16	120	Each
L407140G30	Extra Stiff	30	7 x 1.25	25	140	Each
L409120G30	Extra Stiff	30	9 x 1.25	53	120	Each

L403100G20



BAINBRIDGE EI 1.3



- ◆ **PRE-PREG CARBON EPOXY** untapered Batten Range
- ◆ Up to 35% lighter for a given stiffness
- ◆ Unique layering process increases inter-laminar bond
- ◆ Laminate construction encapsulated in a multi layer outer casing minimises batten failure
- ◆ Stress is dissipated along the full length of the batten
- ◆ Increased torque stress resistance (twist), where uni-directional milled pultruded battens can fail

L0 Carbon Epoxy

Uniform 10mm Batts

Part No.	Stiffness	Width mm	Thickness mm	EI Number	Length cm	UOM
SOFT						
L0016240C10	Soft	10	1.6 x 1.6	0.5	240	Each
L002240C10	Soft	10	2 x 2	0.8	240	Each
MEDIUM						
L003240C10	Medium	10	3 x 3	3	240	Each
L004240C10	Medium	10	4 x 4	7	240	Each
STIFF						
L005240C10	Stiff	10	5 x 5	13	240	Each

Uniform 15mm Batts

Part No.	Stiffness	Width mm	Thickness mm	EI Number	Length cm	UOM
SOFT						
L0016240C15	Soft	15	1.6 x 1.6	0.5	240	Each
L002240C15	Soft	15	2 x 2	0.8	240	Each
MEDIUM						
L003240C15	Medium	15	3 x 3	3	240	Each
L004240C15	Medium	15	4 x 4	7	240	Each
STIFF						
L005240C15	Stiff	15	5 x 5	13	240	Each

L2 Carbon Epoxy

10mm Batts

Part No.	Stiffness	Width mm	Thickness mm	EI Number	Length cm	UOM
MEDIUM						
L203040C10	Medium	10	4 x 1	3	100	Each
L203050C10	Medium	10	4 x 1	3	120	Each
STIFF						
L204060C10	Stiff	10	5 x 1	7	120	Each
L204070C10	Stiff	10	5 x 1	7	140	Each
L204080C10	Stiff	10	5 x 1	7	160	Each
L204090C10	Stiff	10	5 x 1	7	180	Each
L204100C10	Stiff	10	5 x 1	7	200	Each
L205090C10	Stiff	10	5 x 1	13	90	Each
L205100C10	Stiff	10	5 x 1	13	100	Each
L205120C10	Stiff	10	5 x 1	13	120	Each
L205140C10	Stiff	10	5 x 1	13	140	Each
L205120C10	Stiff	10	5 x 1	13	120	Each

L0016240C10



BAINBRIDGE EI 0.5



L4 Carbon Epoxy

Yacht 10mm Battens

Part No.	Stiffness	Width mm	Thickness mm	EI Number	Length cm	UOM
MEDIUM						
L404100C10	Medium	10	4 x 1	7	100	Each
L404120C10	Medium	10	4 x 1	7	120	Each
L404140C10	Medium	10	4 x 1	7	140	Each
L404160C10	Medium	10	4 x 1	7	160	Each
L404180C10	Medium	10	4 x 1	7	180	Each
STIFF						
L405120C10	Stiff	10	5 x 1	13	120	Each
L405140C10	Stiff	10	5 x 1	13	140	Each
L405160C10	Stiff	10	5 x 1	13	160	Each
L405180C10	Stiff	10	5 x 1	13	180	Each
L405200C10	Stiff	10	5 x 1	13	200	Each
L405220C10	Stiff	10	5 x 1	13	220	Each

Yacht 15mm Battens

Part No.	Stiffness	Width mm	Thickness mm	EI Number	Length cm	UOM
STIFF						
L404100C15	Stiff	15	4 x 1	10	100	Each
L405120C15	Stiff	15	5 x 1	19	120	Each
L405140C15	Stiff	15	5 x 1	19	140	Each
L405160C15	Stiff	15	5 x 1	19	160	Each
L405180C15	Stiff	15	5 x 1	19	180	Each
L405200C15	Stiff	15	5 x 1	19	200	Each
L405180C15	Stiff	15	5 x 1.25	19	180	Each
L406100C15	Stiff	15	6 x 1	33	100	Each
L408100C15	Stiff	15	8 x 1.25	77	240	Each

Yacht 20mm Battens

Part No.	Stiffness	Width mm	Thickness mm	EI Number	Length cm	UOM
EXTRA STIFF						
L404100C20	Extra Stiff	20	4 x 1	13	100	Each
L404220C20	Extra Stiff	20	4 x 1.25	13	220	Each
L405160C20	Extra Stiff	20	5 x 1	25	160	Each
L405180C20	Extra Stiff	20	5 x 1	25	180	Each
L405200C20	Extra Stiff	20	5 x 1	25	200	Each
L405220C20	Extra Stiff	20	5 x 1	25	220	Each
L406100C20	Extra Stiff	20	6 x 1	44	100	Each
L408100C20	Extra Stiff	20	6 x 1	103	100	Each

L404100C10  BAINBRIDGE EI 7



Pultruded Vinylester Battens

- ◆ High quality vinylester construction
- ◆ Progressive range of stiffness
- ◆ Ideal for full length battens bridgedeck catamarans, bluewater cruiser for example
- ◆ Only available in full lengths

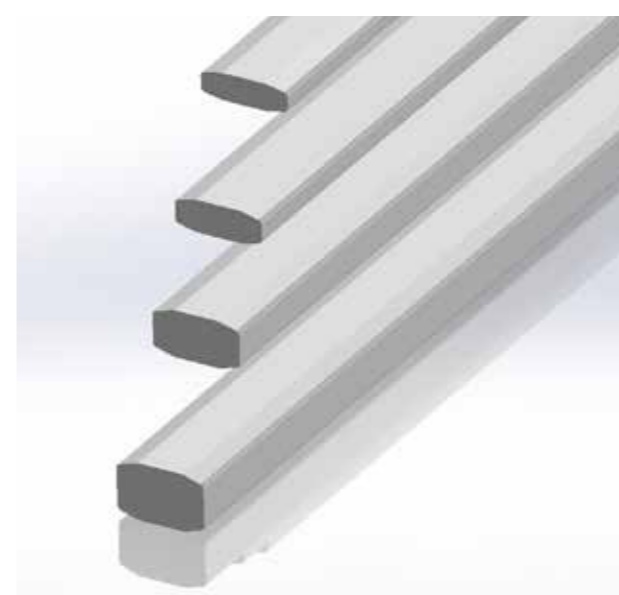
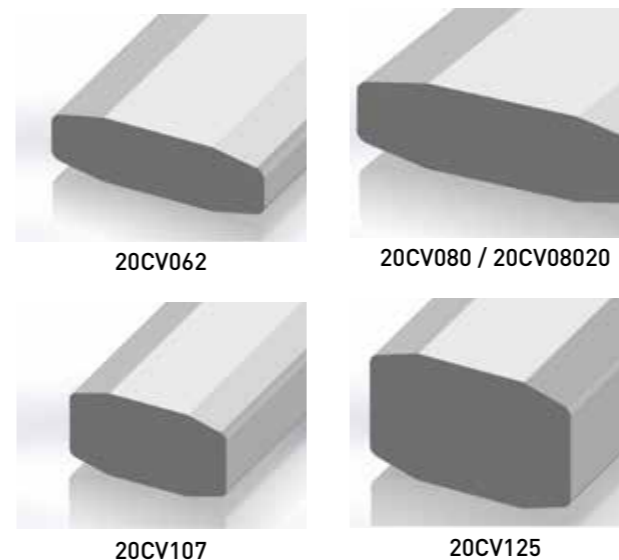

Part No.	Dims. mm	Length m	EI NM2	Weight g/m	Colour
20CV062	20 x 6	12	12.3	212	Grey
20CV080	20 x 8	12	26.5	273	Grey
20CV107	20 x 11	12	63.3	376	Grey
20CV125	20 x 12	12	101	441	Grey
Flat Battens - long reels					
20CV08020	20 x 8	20	26.5	273	Grey



Pultruded Sailman Battens

- ◆ High quality vinylester pultrusions delivering ultimate tenacity for demanding full batten applications
- ◆ Profile shape resists 'snaking', whilst offering weight saving aloft
- ◆ They feature a logical and progressive range of stiffness
- ◆ All in a common 30mm width

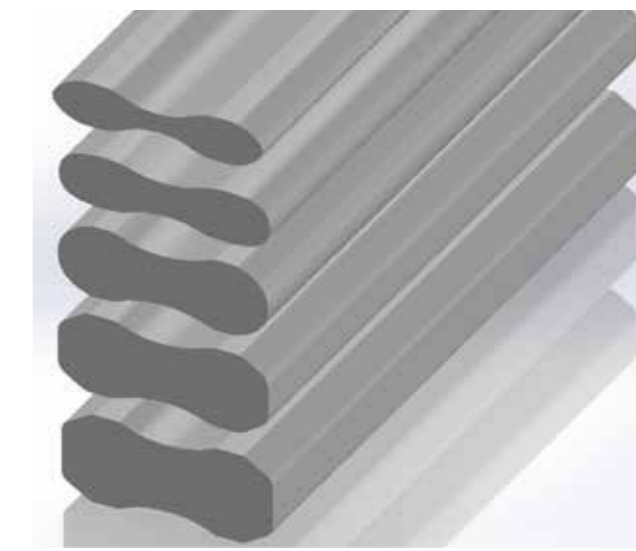
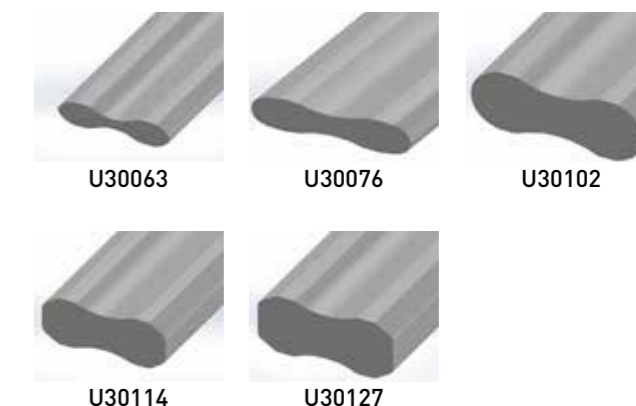

Part No.	Dimensions mm	Length m	EI NM2	Weight g/m	Colour
U30063	30 x 6.3	12	23.3	293	Grey
U30076	30 x 7.6	12	40.4	382	Grey
U30102	30 x 10.2	12	101.6	530	Grey
U30114	30 x 11.4	12	136.8	618	Grey
U30127	30 x 12.7	12	199.3	704	Grey

Pultruded Flat Battens

- ◆ These low cost, quality pultrusions are tough and durable
- ◆ 30CT styles offer logical increases in stiffness and compliment the Sailman battens range
- ◆ Allows consistent use of batten pocket and luff box
- ◆ 16HCP is used by most of the new skiff type dinghy classes
- ◆ Only available in full lengths



Part No.	Dims. mm	Length m	EI NM2	Weight g/m	Colour
15CT	15 x 3.0	6	1.2	60	White
15CTST	15 x 4.0	6	1.7	84	Blue
16HCP	16 x 6.0	6	9.4	108	White
30CT024	30 x 2.0	6	1.1	145	Grey
30CT031	30 x 3.0	6	2.3	188	Grey
30CT044	30 x 4.0	6	7.1	266	Grey
30CT052	30 x 5.0	6	12.7	215	Grey
40CT	38 x 3.0	6	2.8	192	White
40CTST	28 x 5.0	6	12.9	292	Blue

Flat Battens - long reels					
Part No.	Dimensions mm	Length m	EI NM2	Weight g/m	Colour
15CT100	15 x 3.0	100	1.2	60	White
15CTST100	15 x 4.0	100	1.7	84	Blue
30CT024R	30 x 2.0	30	1.1	145	Grey
30CT031R	30 x 3.0	30	2.3	188	Grey
30CT044R	30 x 4.0	30	7.1	266	Grey
30CT052R	30 x 5.0	30	12.7	315	Grey

Pultruded Rod Battens

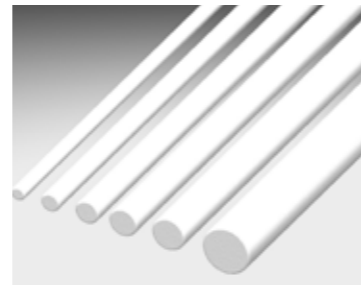

- ◆ Outstanding stiffness to weight combined with low cost make round section pultrusions an excellent choice for full batten applications
- ◆ Considerably better stiffness/weight ratio than flat battens
- ◆ Longer lengths are available against special order

Part No.	Dimensions mm	Length m	EI NM2	Weight g/m	Colour
06R	6	6	3.3	52	White
06RBK	6	6	3.3	52	Black
08R	8	6	11.2	88	White
10R	10	6	25.8	144	White
12R	12	6	53.6	211	White
14R	14	6	99.2	286	White
16R	16	6	169	364	White
20R	20	6	413	560	White

Rod Battens - long reels					
Part No.	Dimensions mm	Length m	EI NM2	Weight g/m	Colour
06R30	6	30	3.3	52	White
06R30BK	6	30	3.3	52	Black
08R30	8	30	10.6	88	White
10R30	10	30	25.8	144	White

Batten Connectors

- ◆ Manufactured in 316 stainless steel
- ◆ Available in 8,10,12,14,16 and 20mm internal diameter
- ◆ Compatible with all Bainbridge pultruded rod batten stock
- ◆ Simple mechanical fix to link battens
- ◆ Same size screw throughout range enables a 'tapered' rod batten
- ◆ Genuine Bainbridge UK manufactured item
- ◆ Exclusive to Bainbridge
- ◆ Fix the batten to connector with J43* tapes or glue page 104



Part No.	Dimensions mm	Material	Pack Qty
BC08S	8	Stainless Steel	Each
BC10S	10	Stainless Steel	Each
BC12S	12	Stainless Steel	Each
BC14S	14	Stainless Steel	Each
BC16S	16	Stainless Steel	Each
BC20S	20	Stainless Steel	Each

Endcaps for Round Battens

- ◆ Manufactured from nylon
- ◆ Spreads load at end of sail pocket
- ◆ Simple to secure battens in pockets



Part No.	Use with Battens	Width mm	Pack Qty
06REC	06R	20	10
08REC	08R	20	10
10REC	10R	32.5	10
12REC	12R	32.5	10
14REC	14R	50	10
16REC	16R	50	10
20REC	20R	50	10

Batten Tensioners & End Fittings

- ◆ Suitable for use with full batten mainsails on catamarans / skiffs up to 6m/20ft - ice boats
- ◆ Attach into size 00 grommets on each side of the batten pockets



Part No.	Max Batten Thickness mm	Pack Qty
A082	8	10

Endcaps for Flat Battens

- ◆ Use these endcaps for all batten styles



Part No.	Use with Battens	Overall Width mm	UOM
10DXSTECI	Aquabatten 10mm	10	Each
10DECO	Aquabatten 10mm	10	Each
10DECI	Aquabatten 10mm	10	Each
10EC002	Aquabatten 10mm	10	Each
15DNEC1	Aquabatten 15mm	18	Each
15DNECO	Aquabatten 15mm	18	Each
15DXSTECIWT	15CTST, 16HCP & Aquabatten 15mm	20	Each
15EC002	Aquabatten 15mm	19	Each
15EC006	Aquabatten 15mm	19	Each
15CTECI	15CT	20	Each
15CTECO	15CT	20	Each
15DXSTECI	15CTST & 16HCP	20	Each
20EC002	Aquabatten 20mm	23	Each
20EC006	20CV062/80 & Aquabatten 20mm	23	Each
20EC010	20CV107/125 & Aquabatten 20mm	23	Each
25CTJM	25NTM	28	Each
30CEC	30CT024 & 30CT031	35	Each
30CTEC	30CT044 & 30CT052	35	Each
40CEC	40CT & 40CTST	42	Each
A150	16HCP	28	Each
A151	15 & 16mm	28	Each

Batten Pocket Protectors for Dinghy Sails

- ◆ Semi-circular seat permits wide range of batten angles - A001
- ◆ Smoothly radiused nose gives low friction contact with the mast
- ◆ Supplied with fixing screws



Part No.	X = mm	Y = mm	Max Cavity Depth mm	Max Batten Width mm	Attachment Type	Pack Qty
A000	30	46	15	15	Rivet	100
A001	19	42	14	15	Screw	100

Batten Pocket Protectors for Dinghy & Catamaran Sails

- ◆ Semi-circular seat permits wide range of batten angles
- ◆ Smoothly radiused nose gives low friction contact with the mast
- ◆ A002 supplied with screws
- ◆ A004 supplied with rivets, use C324 closing tool see page 52



Part No.	X = mm	Y = mm	Max Cavity Depth mm	Max Batten Width mm	Attachment Type	Pack Qty
A002	31	65	25	30	Screw	100
A004	31	65	25	30	Rivet	100

Batten Pocket Protectors for Larger Yacht Sails

- ◆ Method of attachment gives excellent resistance to side loads
- ◆ Smoothly radiused nose gives low friction contact with the mast
- ◆ Supplied with screws and nuts



Part No.	X = mm	Y = mm	Max Cavity Depth mm	Max Batten Width mm	Attachment Type	Pack Qty
A005	39	82	30	60	Screw	25
A006	37	70	25	40	Nut & Bolt	50

Batten Pocket Protectors for Catamaran & Full Batten Dinghy Sails

- ◆ Internal shape permits wide range of batten angles
- ◆ High strength design with high load screws to resist end thrust of stiff battens
- ◆ Smoothly radiused nose gives low friction contact with the mast
- ◆ Supplied with screws

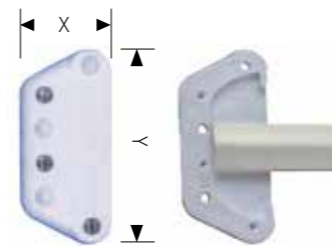

Part No.	X = mm	Y = mm	Max Cavity Depth: mm	Max Batten Width: mm	Attachment Type	Pack Qty
A302	30	65	20	30	Screw	10

Batten Pocket Elastic

- ◆ Manufactured from woven elastic which does not narrow under stretch
- ◆ Polyester covering
- ◆ Only available in full rolls

Part No.	Roll Length m	Width mm	UOM
E551	25	19	Metre
E552	25	25	Metre
E553	25	38	Metre



End Fittings for 30mm Flat Battens

- ◆ Manufactured from reinforced nylon, with type 316 stainless steel screws
- ◆ Superior backplate/cover design
- ◆ Can be used as a leech fitting or luffbox with Allslip slides
- ◆ Attaches to slide with webbing
- ◆ Supplied with screws and locking nuts

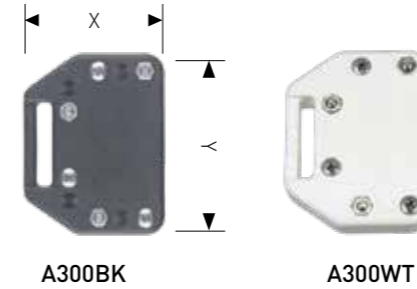

Part No.	X = mm	Y = mm	Max Cavity Depth mm	Max Batten Width mm	UOM
A300BK	43	55	25	30 x 6.5	Each
A300WT	43	55	25	30 x 6.5	Each

End Fittings for 45mm Flat Battens

- ◆ Manufactured from reinforced nylon, with type 316 stainless steel screws
- ◆ Can be used as a leech fitting or luffbox with Allslip slides
- ◆ Attaches to the slide with webbing or with shackle: B303 below right
- ◆ Supplied with screws and locking nuts

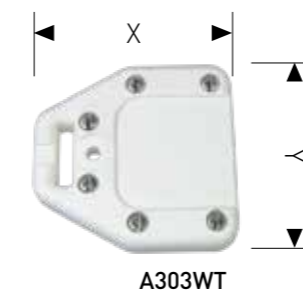

Part No.	X = mm	Y = mm	Max Cavity Depth mm	Max Batten Width mm	UOM
A303BK	80	76	47	45 x 7	Each
A303WT	80	76	47	45 x 7	Each

End Fittings for Round Battens

- ◆ Manufactured in reinforced nylon, with type 316 stainless steel fastenings
- ◆ Can also be used as a leech fitting
- ◆ Compression screws manufactured in type 316 stainless steel
- ◆ A305 dimensions: 97mm x 44mm
- ◆ A306 dimensions: 130mm x 55mm



A305BK / A306BK



A305WT



A305SS | A306SS

Part No.	Comprising	Use with	UOM
A305BK	Black with backplate & attaching screws / nuts & compression screw	06R - 12R	Each
A305WT	White with backplate & attaching screws / nuts & compression screw	06R - 12R	Each
A305SS	Stainless steel screw	A305	Each
A306BK	Black with backplate & attaching screws / nuts & compression screw	16R - 20R	Each
A306SS	Stainless steel screw	A306	Each

Shackle for Attachment of A303

- ◆ Manufactured from type 316 stainless steel fittings
- ◆ Custom designed for use with A303BK or A303WT



Part No.	Length mm	Width mm	UOM
B303	42	12	Each

Small Fittings for Battens from 10mm to 12mm diameter

- ◆ Moulded from reinforced nylon
- ◆ All fixings are in light-weight alloy
- ◆ Luff box connects to slide with M10 thread
- ◆ Fitting dimensions:
A4121 - 80mm x 50mm
A4122 - 65mm x 50mm



A4121 - Leech A4122 - Luff

Part No.	Comprising	Type	UOM
A4122	Box complete with backplate / attaching screws and nuts	Luff	Each
A4121	Box complete with backplate / attaching screws and nuts / compression screw	Leech	Each

Medium Fittings for Battens from 12mm to 16mm diameter

- ◆ Moulded from reinforced nylon
- ◆ All fixings are in light-weight alloy
- ◆ Luff box connects to slide with M10 thread
- ◆ Fitting dimensions:
A4162 - 80mm x 50mm
A4161 - 80mm x 50mm



A4162 - Luff A4161 - Leech

Part No.	Comprising	Type	UOM
A4162	Box complete with backplate / attaching screws and nuts	Luff	Each
A4161	Box complete with backplate / attaching screws and nuts / compression screw	Leech	Each

Large Fittings for Battens from 16mm to 20mm diameter

- ◆ Moulded from reinforced nylon
- ◆ All fixings are in light-weight alloy
- ◆ Luff box connects to slide with M10 thread
- ◆ Fitting dimensions:
A4202 - 100mm x 50mm
A4201 - 120mm x 50mm



A4202 - Luff A4201 - Leech

Part No.	Comprising	Type	UOM
A4202	Box complete with back-plate / attaching screws and nuts	Luff	Each
A4201	Box complete with back-plate / attaching screws and nuts / compression screw	Leech	Each

SDA Batten Fittings - Compression Screws

- ◆ Alloy Screw



Part No.	Description	UOM
A4121S	For use with A4121	Each
A4161S	For use with A4161	Each
A4201S	For use with A4201	Each

Track Slides

Track Slide Measurements

Bainbridge International's track slides have been carefully designed to allow compatibility with the widest possible range of mast sections. Design and material selection leads to trouble-free use and maximum strength even under the most arduous conditions. High strength metal slides are also available for each type of track to be used in the more highly stressed head and clew positions.

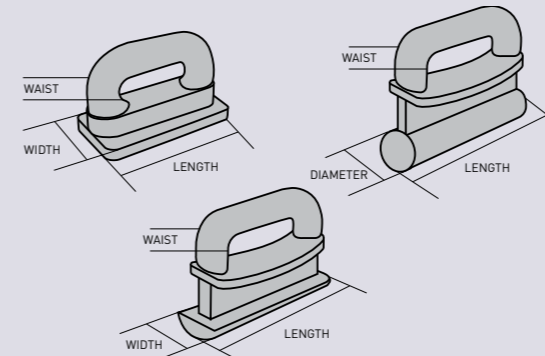

Internal Flat Slides - Plastic

- ◆ Injection moulded from nylon 66



Part No.	Width mm	Waist mm	Length mm	Pack Qty
A007	15.8	6.8	30	10
A008	19	9	33	10
A009	22	11	35	10



Part No.	Width mm	Waist mm	Length mm	Pack Qty
A006MBK	20	10	34	10
A008MBK	24	11	34	10

Bronze Flat Sail Slide

- ◆ Designed for use in metal mast system
- ◆ Used at the headboard, clew outhaul or around/near luff reefings



Part No.	Width mm	Waist mm	Length mm	Pack Qty
B006	20	10	34	10

Internal Flat Slides - Stainless Steel

- ◆ Cast Stainless Steel, electro-polished
- ◆ Low friction PTFE coating



Part No.	Width mm	Waist mm	Length mm	Pack Qty
B307	16	7	40	10
B308	20	7	40	10
B309	22	7	40	10

Proctor Mast Slides

- ◆ Cast stainless steel encapsulated in low friction injection moulded nylon



Part No.	Width mm	Waist mm	Length mm	Pack Qty
B008	21	10	50	10
B009	24	11	50	10
B010	30	16	50	10

Selden Mast Slides - Plastic



A011 / A012 A013 / A014 / A015

Part No.	Width mm	Waist mm	Length mm	Pack Qty
A013	11	3	22	10
A014	14	4	30	10
A015	15	4	40	10
A011	20	8.5	30	10
A012	20	8.5	40	10

Selden Mast Slides - Stainless Steel

- ◆ Cast stainless steel, electro-polished
- ◆ Low friction PTFE coating



Part No.	Width mm	Waist mm	Length mm	Pack Qty
B044	14	4	37	10

Internal Slug Slides - Plastic

- ◆ Injection moulded from nylon 66



Part No.	Diameter mm	Waist mm	Length mm	Pack Qty
A016	7.5	3	27	10
A017	9	3	27	10
A018	12	3	27	10
A019	14	3	25	10

Kiwi Sew-on Sail Slides

- ◆ Easily installed by sewing directly onto the sail
- ◆ No shackles required
- ◆ Can be used in groove headstay systems
- ◆ Low friction



Part No.	Width mm	Length mm	Pack Qty
A310	5.6	33	10
A313	8	33	10
A315	10	33	10

Allslip Low Friction Slide

- ◆ Seven profiles to fit most modern spars
- ◆ Precision moulded from glass fibre reinforced plastic with a PTFE impregnation
- ◆ Integral compression pad transfers loads on to aft face of spar
- ◆ A114 is designed for use in Selden sections fitted with flush gates



A116 A117 A118 A114 A107 A108 A109

Part No.	Width mm	Waist mm	Length mm	Pack Qty
A116	7.5	4	45	10
A117	8.5	4	45	10
A118	11.5	4	45	10
A114	15.5	4.4	45	10
A107	15.8	7	45	10
A108	19	9	45	10
A109	22	11	45	10

Slug Slides with Welded Stainless Steel Bail

- ◆ Moulded-in welded bail gives maximum strength



Part No.	Diameter mm	Waist mm	Length mm	Pack Qty
A016S	6.9	2.5	27	10
A017S	8	2.5	27	10
A019S	10	3.2	30	10
A018S	11	3.4	30	10

Internal Slug Slides - Stainless Steel

- ◆ Cast stainless steel, electro-polished
- ◆ Low friction PTFE coating



Part No.	Diameter mm	Waist mm	Length mm	Pack Qty
B035	7.5	3.5	37	10
B036	8.6	3.5	37	10
B037	10.5	3.5	37	10

Heavy Duty Slug Slides with Moulded in Bail

- ◆ Injection moulded in low-friction nylon, with captive stainless steel bail
- ◆ A031C is designed for modern dinghy booms with very narrow groove openings
- ◆ Also used as a floating tack to give close-in attachment of sail to mast



Part No.	Width mm	Waist mm	Length mm	Pack Qty
A031C	8	1.7	50	10
A031	8	3	50	10
A032	9	3	50	10
A033	12	4	73	10

Internal Slug Slides - Cast Alloy

- ◆ Diecast in aluminium alloy and coated with PTFE

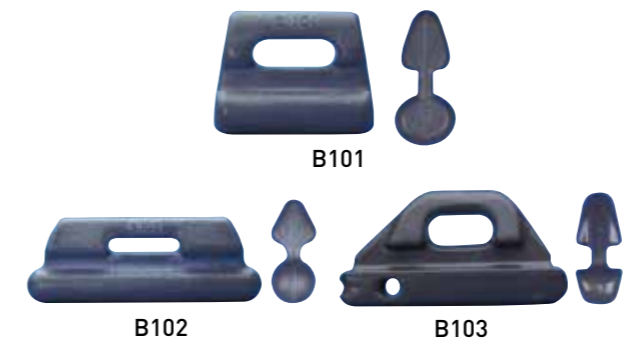

Part No.	Diameter mm	Waist mm	Length mm	UOM
B101	11	2.5	31	Each
B102	11	4	73	Each
B103	12	4	78	Each

Heavy Duty Slug Slides - Stainless Steel

- ◆ Diecast in stainless steel, electro-polished
- ◆ Low friction PTFE coating
- ◆ Can also be used for head slides



Part No.	Diameter mm	Waist mm	Length mm	Pack Qty
B011	7.5	3	74	10
B012	9	3	75	10
B013	12	3	75	10

External Slides - Stainless Steel

- ◆ Type 316 stainless steel, electro polished slide
- ◆ Specifically designed for external track systems
- ◆ Attach to sail with webbing or lashing
- ◆ Recommend EW352 lacing line for lashing to sail on page 120



Part No.	Track Size mm	Pack Qty
B014SS	15	10
B015SS	22	10
B016SS	25	10

Screw-On Shackles - Plastic

- ◆ Bainbridge plastic shackles are designed for ease of use, high strength and ability to absorb shock loads
- ◆ Injection moulded from a tough nylon to absorb sudden impact loads
- ◆ A027 to be used with A007/A008/A013/A016/A017/A018/A019
- ◆ A026 and A028 to be used with A009/A014
- ◆ Shackles supplied complete with screws
- ◆ The screw design offers strength and permits ease detachment and reattachment



A027 / A026

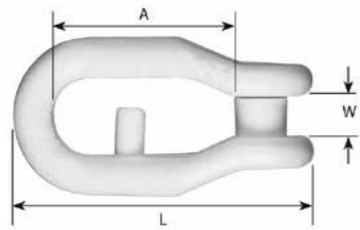

A028

Part No.	Description	A mm	L mm	W mm	Pack Qty
A027	Small/Standard	28	45	10	10
A026	Large/Standard	27	47	11	10
A028	Large/Anti-jamming	27	47	11	10

Snap-In Shackles - Plastic

- ◆ Injection moulded from a tough nylon to absorb sudden impact loads
- ◆ Unique design of snap to give reduced elongation under load and higher strength often preferred as an easier to fit alternative
- ◆ A023 to be used with A007/A008/A013/A016/A017/A018/A019
- ◆ A024 to be used with A009/A014

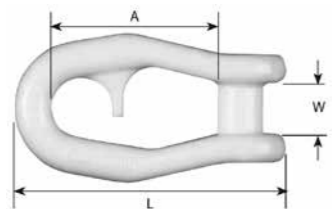

A023 / A024

Part No.	Description	A mm	L mm	W mm	Pack Qty
A023	Small/Anti-jamming	22	39	10	10
A024	Large/Anti-jamming	28	45	11	10

Shackle for attachment of A303

- ◆ Manufactured from type 316 stainless steel fittings
- ◆ Custom designed for use with A303BK, A303WT and Allslip slides



Part No.	Length mm	Width mm	UOM
B303	42	12	Each

Screw Shackles - Stainless Steel



Part No.	To be used with	L mm	W mm	Pack Qty
B129	A016S - A018S & B014 - B016	16	10	10
B130	A016S - A018S & B014 - B016	20	10	10
B131	A016S - A018S & B014 - B016	24	10	10
B110	A031 - A033 & B307 - B309	34	15	10



Stainless Steel Key Pin Shackle with Bar

- ◆ Working loads shown are according to manufacturer's data and are dependent on application

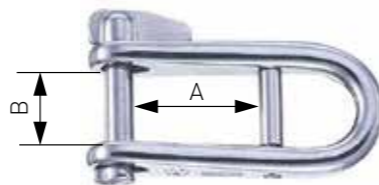

Part No.	Wichard Number	Overall Dims: mm L x W	Internal Dims: mm A - B	SWL kg	UOM
B536	81432	49 x 31	37 - 13	400	Each

Long Reach Screw-On Shackles

- ◆ A035BK to be used with all 7 Allslip slides as well as: A007, A008, A009, A017 and A018 to full batten sails including those equipped with Sailman 3000, 3500 and 4000 systems.
- ◆ Unique anti-jamming design retains the slide at the head of the shackle
- ◆ Colour co-ordinated to match Sailman and Allslip slides
- ◆ Screw-on closure for extra strength, supplied complete

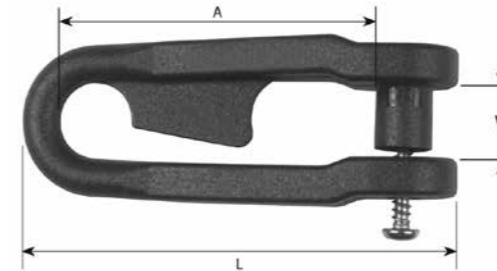

Part No.	A mm	L mm	W mm	Pack Qty
A035BK	45	61	11	10

Shackle Protectors

- ◆ Cut from clear vinyl

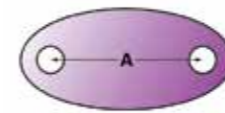

Part No.	To be used with	A mm	Pack Qty
A515	B129	34	100
A516	B130	37	100
A517	B131	51	100
A518	B110	59	100



Soft Shackle

- ◆ Made out of HMPE
- ◆ Will not rust or corrode
- ◆ Light and easy to handle
- ◆ Will not damage soft surfaces around it
- ◆ No tools required



Part No.	Dimensions mm	Pack qty
AQM027403	3 x 40	2
AQM027554	4 x 55	2
AQM027755	5 x 75	2
AQM027906	6 x 90	2

Twist-On Plastic Jib Hanks

- ◆ Ideal for dinghies, dayboats and sportsboats up to 25ft
- ◆ Supplied with screws



Part No.	Size	Length mm	Forestay Dia. mm	Pack Qty
A038	Small	30	3.5	100
A039	Large	30	5	100

Plastic Piston Hanks

- ◆ Ideal for sportsboats and daysailers such as J24 and 1720



Part No.	Length mm	Forestay Dia. mm	Pack Qty
A188A	50	6.4	10

Swedish Forged Brass Piston Hanks

- ◆ Swedish brass jib hanks are renowned world-wide for quality, reliability and ease of fitting
- ◆ Forged from marine quality brass and fitted with stainless steel spring
- ◆ B516 has a jaw opening of 255mm and internal dimensions of 25mm x 29mm. It is designed for use over forestay systems for storm jibs, not for large genoas



Part No.	Size	Length mm	Max. Forestay mm	Pack Qty
B510	0	44	8	10
B511	1	52	9	10
B512	2	65	12	10
B513	3	74	15	10
B514	4	82	17	10
B515	5	95	20	10
B516	6	107	25	10





Stainless Steel Jib Hanks

- ◆ Easy to install - single handed operation
- ◆ Efficient use - helps prevent system jamming



Part No.	Wichard Number	Length mm	Max. Forestay mm	UOM
B506	2486	50	8	Each
B504	2483	55	9	Each
B507	2487	65	11	Each
B505	2489	80	12	Each
B508	2488	90	15	Each



Bronze Jib Hanks

- ◆ Easy to install - single handed operation
- ◆ Efficient use - helps prevent system jamming



Part No.	Wichard Number	Length mm	Max. Forestay mm	Pack Qty
B701	72486	50	8	10
B702	72483	55	9	10
B703	72487	65	11	10

Jib Hank Protectors

- ◆ Cut from clear vinyl
- ◆ UK manufactured
- ◆ Sold in full packs only



Part No.	To Be Used With	Pack Qty
A511	B506 / B510 / B511 / B701	100
A512	B504 / B507 / B512 / B702 / B703	100
A513	B505 / B513	100
A514	B508 / B514 / B515	100

Sister Clips

- ◆ Allows fast and positive sheet attachment to sail
- ◆ Use on one-design or light air spinnakers



Part No.	Length mm	Pack Qty:
B605	38	10



Tylaska Tack Shackles

- ◆ Allows fast and positive sheet attachment to sail
- ◆ Use as tack fitting on code headsails
- ◆ Single handed operation
- ◆ Working load shown is according to manufacturer's data and is dependent on application

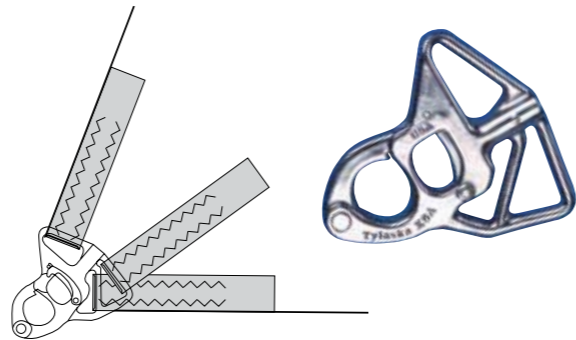

Part No.	Length mm	Safe Working Load kg	UOM
B710	73	1800	Each



Stainless Steel Tack Hooks

- ◆ Working loads shown are according to manufacturer's data and are dependent on application



Part No.	Wichard Number	Length mm	Safe Working Load kg	UOM
B517	2479	35	80	Each
B518	2480	50	250	Each
B519	2481	75	600	Each
B520	2482	100	1400	Each
B528	2381	75	1100	Each
B529	2382	100	2100	Each
B531	2313	60	450	Each
B532	2315	80	1100	Each



Snap Hooks

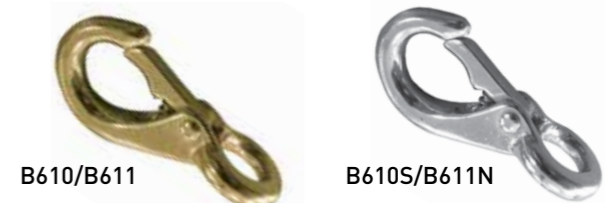

Part No:	Length mm	Eye mm	Break Load kg	Material	Pack Qty
B610S	53	10	-	AISI 304 Stainless Steel	10
B610	53	10	-	Brass	10
B611	72	15	-	Brass	10
B611N	72	15	-	Nickel plated brass	10

Fast Rigid Snap Hook for Webbing



Part No:	Length mm	Eye mm	For webbing diameter mm	Material	Pack Qty
B617S	50	25	Up to 25.4	AISI 304 Stainless Steel	10



Fast Rigid Snap Hook



Part No:	Length mm	Eye mm	Break Load kg	Material	UOM
AQM054722	55	10	130	AISI 316 Stainless Steel	Each
AQM054723	73	16	160	AISI 316 Stainless Steel	Each

Fast Swivel Snap Hook



Part No:	Length mm	Eye mm	Break Load kg	Material	UOM
AQM054726	86	6	150	AISI 316 Stainless Steel	Each
AQM054727	100	20	250	AISI 316 Stainless Steel	Each
B632	64	10	-	Bronze	Each
B611SW	81	15	-	Bronze	Each



Leech Line Blocks



Part No.	Description	Rope	UOM
SPR35420016A0	Lightweight composite block 16 x 5mm	4mm Dia	Each
SPR3532060055	Micro XS Block - Ball Race 19 x 8.3mm	10mm Dia	Each
SPR3522500155	Super Mini Block - Plain Bearing 16 x 6mm	6mm Dia	Each

Clew & Reef Blocks

- ◆ Available to suit boat sizes up to 25 metres
- ◆ Ideal for inmast furling mainsails
- ◆ Manufactured in dark grey anodised, marine grade aluminium, sheaves and fibre rollers
- ◆ Clew Blocks: Symmetrical both sides
- ◆ Reef Blocks: One side is flat so that it can lay flat against the sail

Clew Blocks



Part No:	Description	Application	Boat size: ft	Rope size: mm	Sheave size: mm	SWL: kg	UOM
BCB042	Clewblock	Outhaul	23-32	8	42	625	Each
BCB050	Clewblock	Outhaul	23-32	10	50	750	Each
BCB070	Clewblock	Outhaul	32-52	12	70	1750	Each
BCB100	Clewblock	Outhaul	45-59	14	100	1750	Each



Part No:	Description	Application	Boat size: ft	Rope size: mm	Sheave size: mm	SWL: kg	UOM
BCR070	Clewblock Race	Outhaul	32-52	14	70	1200	Each
BCR100	Clewblock Race	Outhaul	45-59	16	100	2500	Each

Reef Blocks



Part No:	Description	Application	Boat size: ft	Rope size: mm	Sheave size: mm	SWL: kg	UOM
BR042	Reefblock	Reef	23-32	8	42	-	Each
BR050	Reefblock	Reef	23-32	10	50	-	Each
BR070	Reefblock	Reef	32-52	12	70	-	Each

Tylaska Snap Shackles

- ◆ Tylaska shackles, meticulously designed and computer optimised using the latest finite element CAD software
- ◆ Aerospace grade 17-4PH stainless steel construction gives Tylaska shackles the ultimate in strength-to-weight ratios
- ◆ Tylaska's patented mathematical curvature of the release mechanism allows the shackles to be easily opened even under tremendous loads
- ◆ Detailed assembly, finishing and individual testing provides the sailor with confidence in strength, performance, and durability

Standard Bail Snap Shackles



Part No	Measurements mm						SWL kg	Breaking Load kg	Weight g	UOM
	A	B	C	D	E	F				
TYT5	13.5	12.7	76.7	5.8	7.6	11.1	1130	2270	62	Each
TYT8	16	14.6	88.5	7.1	9.7	13.7	1810	3630	99	Each
TYT12	18	18.2	103.7	8.4	11.1	16	2720	5440	167	Each
TYT16	22.9	20.1	120.3	9.7	12.7	18.5	3630	7260	258	Each
TYT20	25.1	25.1	134	11.4	14	19	4540	9070	360	Each
TYT30	31.2	30.5	166.4	14.2	19.6	24.7	6800	13610	760	Each

Large Bail Snap Shackles



Part No	Measurements mm						SWL kg	Breaking Load kg	Weight g	UOM
	A	B	C	D	E	F				
TYT5L	13.5	20.6	85.6	7.4	7.6	11.1	1130	2270	62	Each
TYT8L	16	24.1	99.9	8.6	9.7	13.7	1810	3630	128	Each
TYT12L	18	28.3	117.3	11.4	11.1	16	2720	5440	230	Each
TY1016-L	22.9	33.3	137.5	13.5	12.7	18.5	3630	7260	363	Each
TYT20L	25.1	35.3	147.1	14.2	14	19	4540	9070	451	Each
TYT30L	31.2	44.8	185.7	18.8	19.6	24.7	6800	13610	899	Each

J Lock Shackles



Part No	Measurements mm						Thickness mm	Line Size mm	SWL kg	Breaking Load kg	Weight g	UOM
	A	B	C	D	E	F						
TYJ8	53.9	26.9	26.9	15.7	11.2	10.7	8.9	8-10	1814	3629	54	Each
TYJ12	61.7	30.7	30.5	17.5	12.7	12.2	9.91	10-12	2722	5443	82	Each
TYJ20	77	38.9	38.1	21.3	16	16	12.4	12-16	4536	9072	167	Each
TY1330	103.1	49.3	45.2	26.4	19	20.3	24.9	14-20	6804	13608	403	Each

Knurled Fids

- ◆ Hi-tech fids, machined from solid aircraft 6061-T6 aluminium
- ◆ Knurled for more secure grip
- ◆ Available in three sizes
- ◆ All handheld fids are anodized in a choice of either blue, black or red
- ◆ Front taper fits all designated Tylaska shackles as well as many other brands
- ◆ The rear thru hole allows easy attachment of a lanyard or wrist leash
- ◆ An indispensable tool for fast and safe release of lines under heavy load

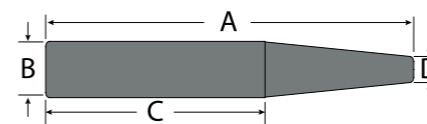

Part No	Measurements mm				UOM
	A	B	C	D	
TY1605	171	19.6	96.5	7.6	Each
TY1606	171	19.6	101.6	4.8	Each
TY1616	228	25.8	134.6	11.9	Each
TY1640	298	40.1	154.9	18	Each



Cone Fids

- ◆ Allows for remote release of trigger shackles
- ◆ Lanyard placed through the centre hole
- ◆ When lanyard is pulled, fids engage trigger, releasing shackle
- ◆ Ideal for avoiding the need to crawl out into risky locations
- ◆ Ideal for single handed or night sailing
- ◆ Both fids hang from trigger area



Single

- ◆ Single cone fids have recessed area to accommodate knot
- ◆ Single cone fid designed to stay in trigger area and remain with shackle

Part No	A mm	B mm	UOM
TY1808	34	5.56	Each
TY1812	43.4	6	Each
TY1820	56.3	7.6	Each
TY1820-SS	56.3	7.6	Each
TY1830-SS	56.3	7.94	Each



Double

- ◆ Come with retaining screw to lock the lanyard in place
- ◆ Designed to go through trigger area and separate from shackle

Part No	A mm	B mm	UOM
TY1908	34	5.16	Each
TY1912	39	6.35	Each
TY1920	52.8	6.35	Each



SPRENGER

Snap Shackles - Stainless Steel

- ◆ Cast, AISI 316 Stainless Steel

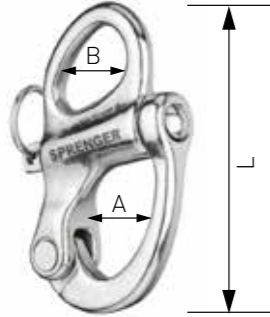

Part no	Size mm L x A x B	Breaking Load kg	UOM
SPR3605303556	35 x 11 x 7	-	Each
SPR3605305056	52 x 12 x 9	1155	Each
SPR3605307056	66 x 16 x 12	2400	Each
SPR3605309556	96 x 22 x 16	3870	Each

Snap Shackles - Stainless Steel

- ◆ Cast, AISI 316 Stainless Steel

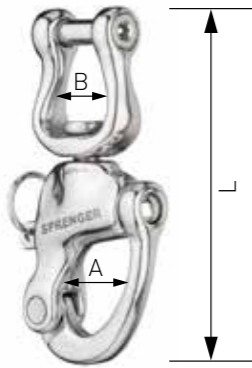

Part no	Size mm L x A x B	Bolt Dia mm	Breaking Load kg	UOM
SPR3605507056	70 x x 16 x 10	6	900	Each
SPR3605509056	90 x 20 x 13	8	2000	Each
SPR3605513056	128 x 30 x 20	10	3800	Each

Snap Shackles - Stainless Steel

- ◆ Cast, AISI 316 Stainless Steel

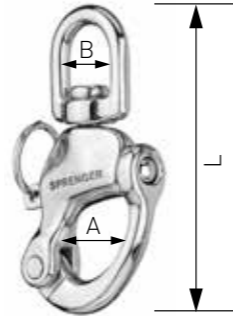

Part no	Size mm L x A x B	Breaking Load kg	UOM
SPR3605407056	70 x 12 x 12	1140	Each
SPR3605409056	87 x 16 x 16	2250	Each
SPR3605412056	120 x 22 x 22	3500	Each

Snap Shackles - Brass

- ◆ Brass II, polished

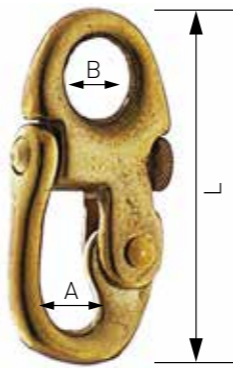

Part no	Size mm L x A x B	Breaking Load kg	UOM
SPR3605004533	45 x 12 x 18	600	Each
SPR3605006033	60 x 13 x 28	650	Each



Halyard Shackles

- ◆ Machined from aerospace grade aluminium plate
- ◆ Hard-coat anodized to military specifications for superior strength and durability
- ◆ Captive 17-4PH stainless steel pin for trouble-free operation
- ◆ Machined thimble surface suitable for permanently spliced fixed halyards

Standard



Part No	Measurements mm										Line Size mm	SWL kg	Breaking Load kg	Weight g	UOM
	A	B	C	D	E	F	G	H	I	J					
TY1405	73.3	27.3	5.6	36.5	22	16.1	12.6	22.3	24.1	6.6	8-11	1130	2270	52	Each
TY1408	80.2	33.5	7.1	38.2	21.2	19.3	14.3	25.4	27.1	8.1	10-12	1810	3630	87	Each
TY1412	95	38.1	7.9	48.3	29	22.4	15.9	28.4	30.7	9.7	11-14	2720	5440	132	Each
TY1420	122.9	46.7	10.7	63.5	38.1	25.4	19	38.1	40.1	12.7	12-16	4540	9070	296	Each

2:1

- ◆ High strength composite sleeve bearing
- ◆ Capable of handling full rated load of shackle
- ◆ Size fits standard sail headboards without adding any unnecessary weight
- ◆ Strength optimized by computer and verified by numerous destructive tests

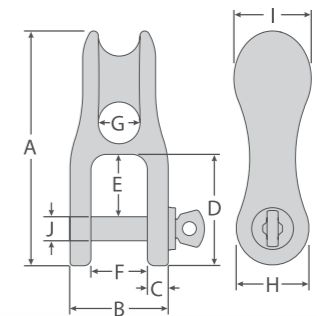

Part No	Measurements mm										Line Size mm	SWL kg	Breaking Load kg	Weight g	UOM
	A	B	C	D	E	F	G	H	I	J					
TY1505	74.1	27.3	5.6	36.5	22	16.1	12.6	22.3	25.1	6.6	8-11	1130	2270	52	Each
TY1508	84.1	33.5	7.1	38.2	21.2	19.3	15	25.4	31.5	8.1	10-14	1810	3630	109	Each
TY1512	103.6	38.1	7.9	50.8	31.7	22.4	16.8	28.4	36.5	9.7	11-16	2720	5440	180	Each
TY1520	133.3	46.7	10.7	63.5	38.1	25.4	22.2	38.1	45.6	12.7	12-18	4540	9070	383	Each



Halyard Shackles

2:1 Split

- ◆ Adds snatch block convenience to all other features
- ◆ Ideal for quick installation and removal from existing rigging

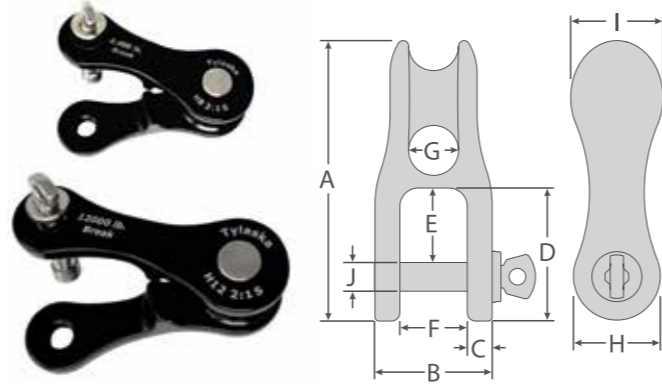

Part No	Measurements mm										Line Size mm	SWL kg	Breaking Load kg	Weight g	UOM
	A	B	C	D	E	F	G	H	I	J					
TY1508-S	84.1	33.5	7.1	38.2	21.2	19.3	15	25.4	31.5	8.1	10-14	1810	3630	109	Each
TY1512-S	103.6	38.1	7.9	50.8	31.7	22.4	16.8	28.4	36.5	9.7	11-16	2720	5440	180	Each



Halyard Shackles

Standard



Part No	Measurements mm				Line Size mm	SWL kg	Breaking Load kg	Weight g	UOM
	J1	J2	Ø Pin						
UBGD812	22	20	8		12	1600	3200	60	Each
UBGD1014	28	24	10		14	2500	5000	93	Each

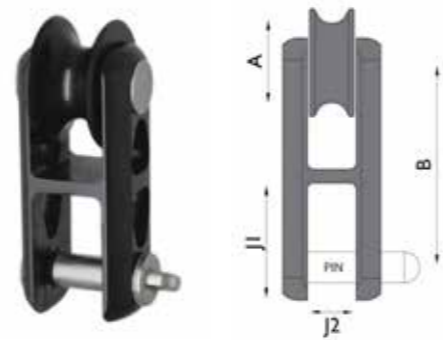

Halyard Shackles

2:1

Part No	Measurements mm					Line Size mm	SWL kg	Breaking Load kg	Weight g	UOM
	J1	J2	Ø A	B	Ø Pin					
UBPD36	37	20	36	55	10	2000	4000	120	Each	Each
UBPD46	48	22	46	70	12	3500	7000	275	Each	Each
UBPD50	58	22	50	85	14	5000	10000	380	Each	



Dogbones

- ◆ Main feature of dogbone design is the tapered design with grooved texture that grabs onto line and prevents slippage
- ◆ Dogbone relies on friction to keep connecting line from slipping off its ends
- ◆ Tapered shank is better, but still does not grip the line
- ◆ Tylaska design has both a taper and multiple surface humps that grip the line but do not cut or damage the fibres
- ◆ Available in both aluminium and stainless steel

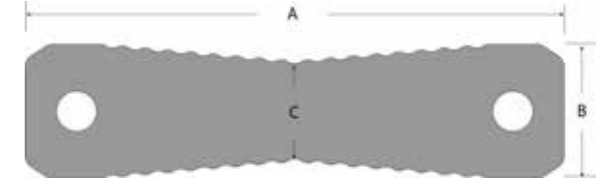

Aluminium

Part No	Measurements mm			Line Size mm	SWL kg	Breaking Load kg	Weight g	UOM
	A	B	C					
TY2506	24	6	4.2	3	300	600	1	Each
TY2508	32	8	5.6	4	550	1100	3	Each
TY2510	40	10	7	6	950	1900	6	Each
TY2512	48	12	8.4	7	1400	2800	11	Each
TY2514	56	14	9.9	8	1900	3800	17	Each
TY2516	64	16	11.3	10	2500	5000	26	Each
TY2518	72	18	12.7	12	3200	6400	34	Each



Stainless Steel

Part No	Measurements mm			Line Size mm	SWL kg	Breaking Load kg	Weight g	UOM
	A	B	C					
TY2506-SS	24	6	4.2	3	650	1300	3	Each
TY2508-SS	32	8	5.6	4	550	1100	9	Each
TY2510-SS	40	10	7	6	2050	4100	17	Each
TY2512-SS	48	12	8.4	7	2950	5900	28	Each
TY2514-SS	56	14	9.9	8	4100	8200	45	Each
TY2516-SS	64	16	11.3	10	5200	10400	68	Each
TY2518-SS	72	18	12.7	12	6800	13600	96	Each
TY2524-SS	96	23.9	17.5	16	11300	22700	249	Each



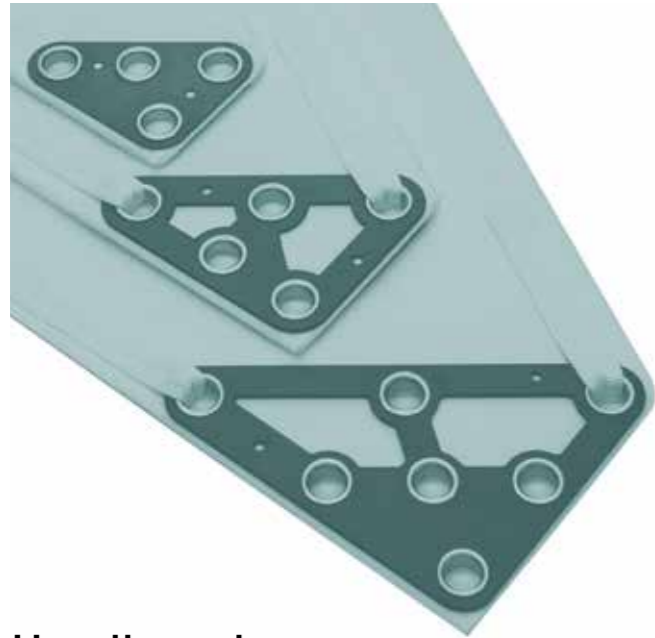

Headboards

A technical design to accommodate the higher loading conditions of modern yachts and sails. The use of stainless steel liners allows faster assembly, with small pilot holes to position accurately during installation. Webbing can be applied for extra security and load holding through the liners. SailmanX headboards can be used in three orientations with option to drill a hole for a slide bridge, allowing for any required sail offset.

- ◆ Smart design gives a strong headboard which is incredibly easy to fit
- ◆ Features heavy radius fillet on all edges - sail damage is substantially reduced
- ◆ Marine grade hard anodised aluminium - 5083 BS EN 573 3.2009
- ◆ Use with D039S/D039N liners
- ◆ No riveting required
- ◆ Colour: Anthracite Grey

Small

- ◆ Aluminium with hard anodised finish
- ◆ Colour: Anthracite Grey

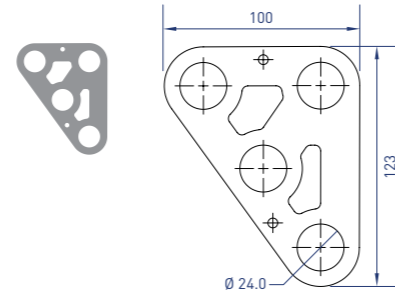

Part No:	Plate: mm	Weight: g	Luff: m	Area: m ²	LOA: ft	SWL: kg	UOM
HBA912GY	2	32	12	35	30	750	Each
HBA913GY	3	48	14	48	35	1,050	Each

Medium Large

- ◆ Aluminium with hard anodised finish
- ◆ Colour: Anthracite Grey

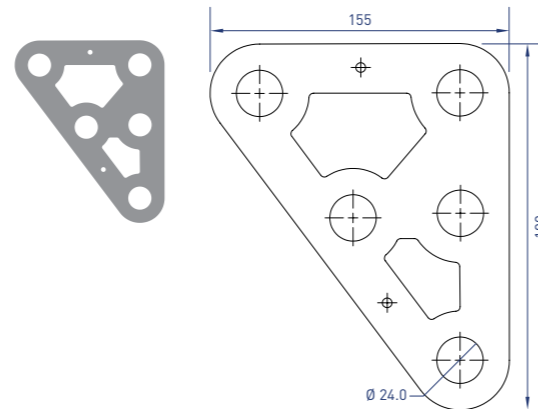

Part No:	Plate: mm	Weight: g	Luff: m	Area: m ²	LOA: ft	SWL: kg	UOM
HBA942GY	3	114	20	98	50	1,300	Each
HBA943GY	4	152	23	129	56	2,400	Each



Weight is for one plate without liners.
SWL given is for installed pair.

Small Medium

- ◆ Aluminium with hard anodised finish
- ◆ Colour: Anthracite Grey

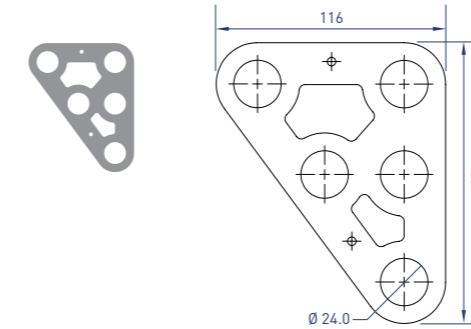

Part No:	Plate: mm	Weight: g	Luff: m	Area: m ²	LOA: ft	SWL: kg	UOM
HBA922GY	2	41	14	48	35	830	Each
HBA923GY	3	61	16	62	40	1,200	Each

Large

- ◆ Aluminium with hard anodised finish
- ◆ Colour: Anthracite Grey

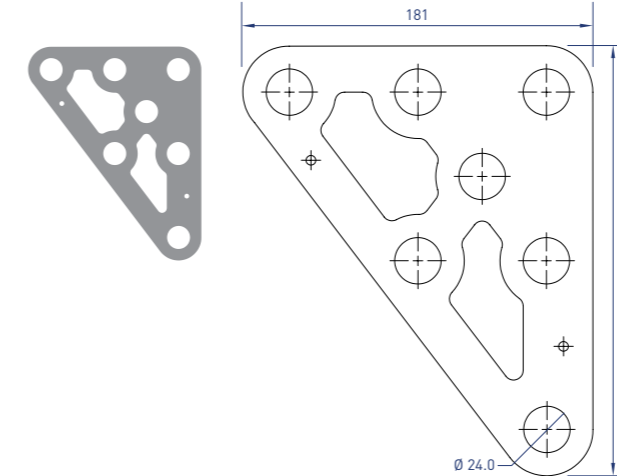

Part No:	Plate: mm	Weight: g	Luff: m	Area: m ²	LOA: ft	SWL: kg	UOM
HBA952GY	3	150	18	79	45	1,900	Each
HBA953GY	4	200	21	108	52.5	2,600	Each

Headboard Liners

- ◆ For use with all SailmanX headboards and clewboards
- ◆ D039S manufactured from type 316 stainless steel
- ◆ D039N manufactured from brass with nickel plated finish

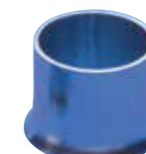

D039S



D039N

Part No.	Dia. mm	Length mm	Use with Closing Tool	Material	Pack Qty
D039S	22	19	C323	Stainless Steel	10
D039N	22	19	C323	Nickel	10

Medium

- ◆ Aluminium with hard anodised finish
- ◆ Colour: Anthracite Grey

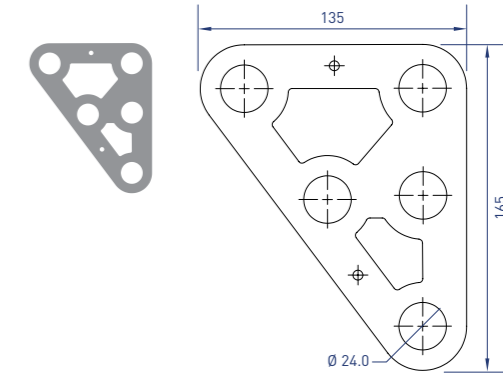

Part No:	Plate: mm	Weight: g	Luff: m	Area: m ²	LOA: ft	SWL: kg	UOM
HBA932GY	2	54	14	48	42.5	950	Each
HBA933GY	3	82	17	71	50	1,400	Each

Extra Large

- ◆ Aluminium with hard anodised finish
- ◆ Colour: Anthracite Grey

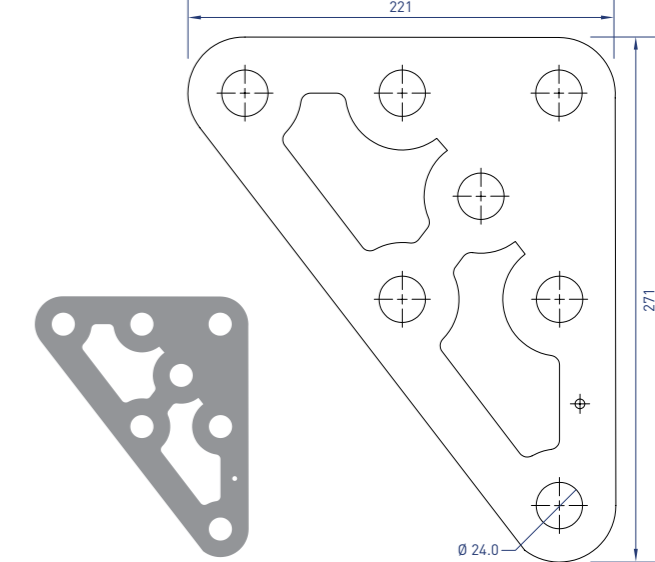

Part No:	Plate: mm	Weight: g	Luff: m	Area: m ²	LOA: ft	SWL: kg	UOM
HBA962GY	3	225	22	118	55	2,450	Each
HBA963GY	4	300	25	153	62.5	3,200	Each



Small

- ◆ Aluminium with hard anodised finish
- ◆ Colour: Anthracite Grey

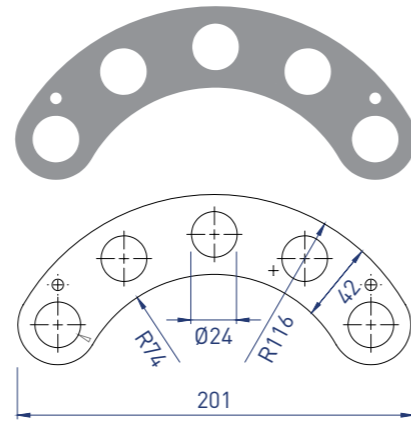

Part No:	Plate: mm	Weight: g	Luff: m	Area: m ²	LOA: ft	SWL: kg	UOM
CBA812GY	2	40	13	32	30	856	Each
CBA813GY	3	60	15	38	37.5	1,200	Each



Weight is for one plate without liners.
SWL given is for installed pair.

Clewboards

These Clewboards are strong and easy to fit and are suitable for a large range of yachts.

With the increasing popularity of self-tacking jibs they are able to cope with the increased loads created by modern yachts. Made in marine grade aluminium with a hard anodised finish, the use of stainless steel liners allows faster installation. Available in various thicknesses to cover the high loading conditions of these sails.

- ◆ 'Strong Arc' shape – stronger and allows integrated fit and appearance to the sail
- ◆ Filleted external edges – on both face and back of plate
- ◆ Marine grade alloy – 5083 BS EN 573 3.2009
- ◆ Use with standard D039S / D039N liners
- ◆ Quick fitting thanks to pilot holes for temporary pins - no slipping, forcing or reworking
- ◆ No riveting required
- ◆ Can be also used in shade sail production

Medium

- ◆ Aluminium with hard anodised finish
- ◆ Colour: Anthracite Grey

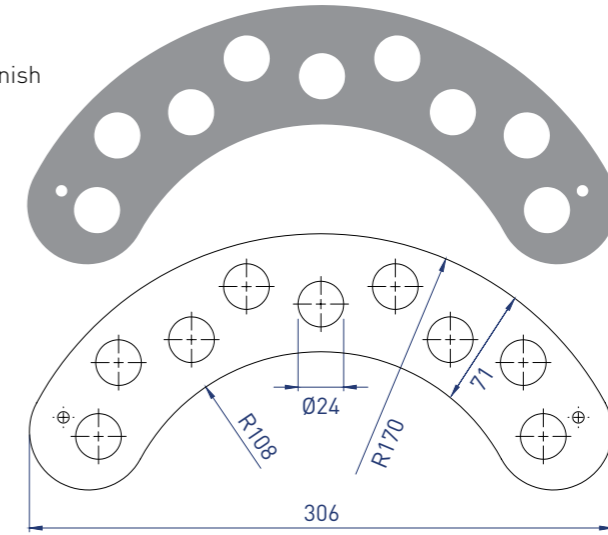

Part No:	Plate: mm	Weight: g	Luff: m	Area: m ²	LOA: ft	SWL: kg
CBA833GY	3	140	18	55	45	1,748
CBA834GY	4	186	23	89	56	2,500

Large

- ◆ Aluminium with hard anodised finish
- ◆ Colour: Anthracite Grey

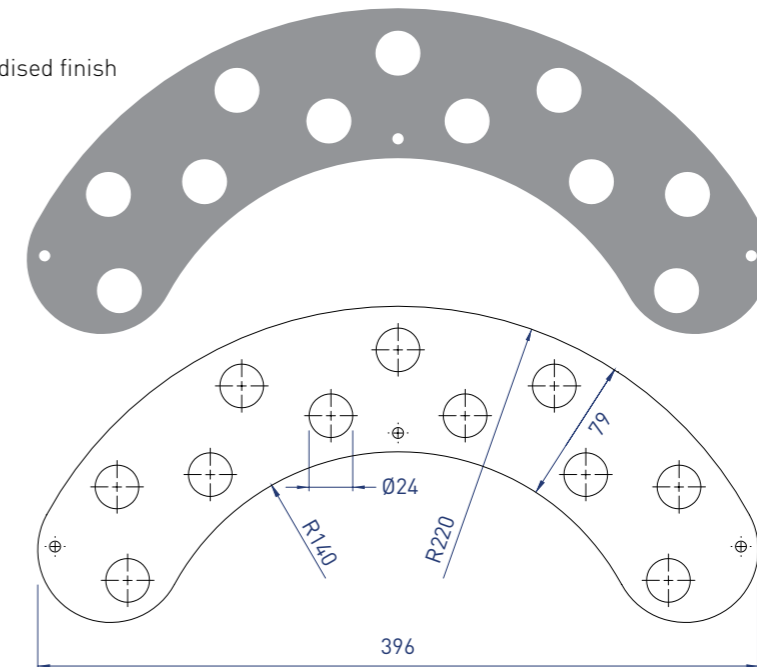

Part No:	Plate: mm	Weight: g	Luff: m	Area: m ²	LOA: ft	SWL: kg
CBA853GY	3	24	21	74	52	1,923
CBA854GY	4	330	25	105	62.5	2,850

Headboard Liners

- ◆ For use with all SailmanX headboards and clewboards
- ◆ D039S manufactured from type 316 stainless steel
- ◆ D039N manufactured from brass with nickel plated finish

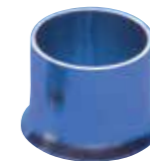

D039S



D039N

Part No.	Dia. mm	Length mm	Use with Closing Tool	Material	Pack Qty
D039S	22	19	C323	Stainless Steel	10
D039N	22	19	C323	Nickel	10

Yacht Headboards

The manufacturing system ensures an extra smooth finish. Burrs that can often wear through webbing and sharp edges that abrade cloth are virtually eliminated.

- ◆ Dual halyard position
- ◆ Manufactured from marine grade aluminium
- ◆ Use D039 liners and D335 - D339 rivets
- ◆ Webbing slot for slide attachment



B909



B910

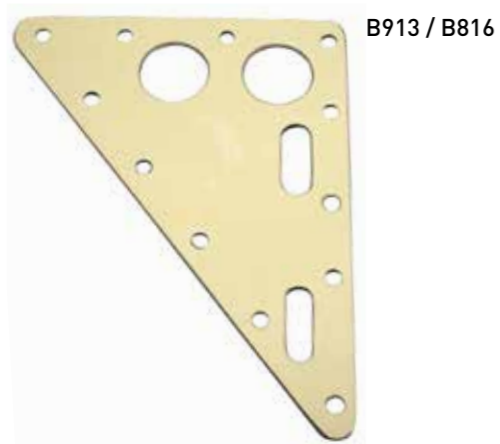

B913 / B816

Part No.	Width mm	Length mm	Thickness mm	Colour	Pack Qty
B909	102	130	1.6	Gold	10
B910	115	146	1.6	Gold	10
B816	152	200	2	Gold	10
B913	153	195	3.2	Gold	10

See page 52 for Headboard Liners
See page 53 for Rivets

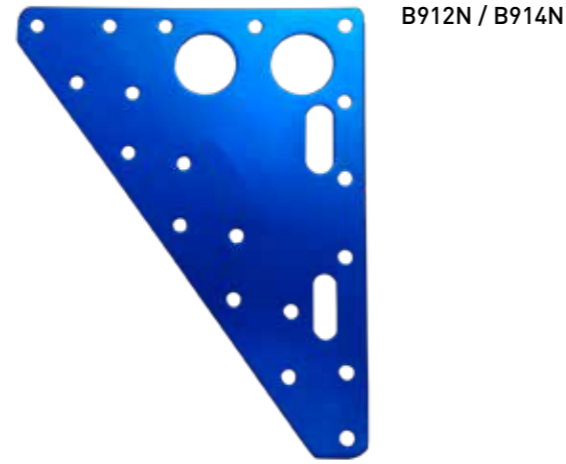

B912N / B914N

Part No.	Width mm	Length mm	Thickness mm	Colour	Pack Qty
B914N	133	165	1.6	Blue	10
B912N	133	165	3.2	Blue	10

Yacht Headboards - Plastic

- ◆ Moulded from ultra rigid glass-filled nylon
- ◆ Smoothly rounded edges and webbing slots give no sail chafe
- ◆ Smoothly rounded liner hole permits liner to sit flat
- ◆ Use D038 liners and D335 - D339 rivets



Part No.	Width mm	Length mm	Thickness mm	Colour	Pack Qty
A052	115	140	3.5	White	10

Dinghy Headboards - Aluminium

- ◆ Uses D037N liner and D331 rivets



Part No.	Width mm	Length mm	Thickness mm	Colour	Pack Qty
B907N	105	115	1.6	Blue	10

See page 52 for Headboard Liners
See page 53 for Rivets

Dinghy Headboards - Plastic

Plastic headboards meet all major dinghy class rules and are made from rigid nylon.

- ◆ Suitable for a wide range of One Design classes
- ◆ Manufactured from a rigid grade of nylon to give maximum leech support
- ◆ Use D037 liners and D331 rivets



Part No.	Width mm	Length mm	Colour	Pack Qty
A043	75	100	White	10
A044	100	115	White	10
A049	115	130	White	10



Part No.	Width mm	Length mm	Colour	Pack Qty
A045	150	150	White	10



Part No.	Width mm	Length mm	Colour	Pack Qty
A048	145	145	White	10

Clewboards

- ◆ Bainbridge clewboards are made from marine grade aluminium and manufactured using a unique system that ensures an extra smooth finish
- ◆ Use with D332-D337/D339 rivets

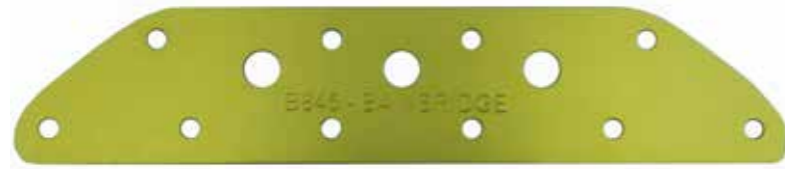

Part No.	Use	Width mm	Length mm	Thickness mm	Colour	Pack Qty
B845	Catamaran	29	140	1.6	Gold	10



Part No.	Use	Width mm	Length mm	Thickness mm	Colour	Pack Qty
B847	Hobie, Soling, F18	38	203	1.6	Gold	10

Headboard Liners

- ◆ For use with all SailmanX headboards and clewboards
- ◆ D037N, D038N, D039N manufactured from brass with nickel plated finish
- ◆ D039S manufactured from type 316 stainless steel



D037N / D038N / D039N

D039S

Part No.	Dia. mm	Length mm	Use with Closing Tool	Material	Pack Qty
D037N	16	16	C321	Nickel	10
D038N	19	19	C322	Nickel	10
D039N	22	19	C323	Nickel	10
D039S	22	19	C323	Stainless Steel	10

Closing Tools

- ◆ Two piece closing tool for setting with hydraulic press
- ◆ All 3 items are supplied with a handle
- ◆ Add the handle to set the liners by hand with a mallet
- ◆ Do not hit with a steel head hammer or mallet, use a rawhide mallet such as C530 or Maul Master, see page 160



Part No.	Use with Liners	UOM
C321	D037N	Each
C322	D038	Each
C323	D039N & D039S	Each

Closing Tools

- ◆ For D331 - D339
- ◆ For best results use a rawhide mallet or Maul Master, see page 160



Part No.	Use with	Pack Qty
C324	D331 - D334 (1/8 inch to 5/32 inch)	Each
C325	D331 - D334 (1/8 inch to 5/32 inch)	Each
C326	D335 - D339 (3/16 inch)	Each



Rivets

Part No.	Dia. mm	Length mm	Use with Closing Tool	Use with Hole Punch	Material	Pack Qty
D331	3.9	9.5	C325	C102	Aluminium	1000
D332	3.2	9.5	C324	C101	Aluminium	1000
D334	3.9	12.7	C325	C102	Aluminium	1000
D335	4.8	9.5	C326	C103	Aluminium	1000
D336	4.2	12.5	C326	C103	Aluminium	1000
D337	4.8	12.7	C326	C103	Aluminium	1000
D339	4.8	15.9	C326	C103	Aluminium	1000
D380	3	11	-	-	Brass	1000
D382	5	11	-	-	Brass	1000

Titanium Low Friction Rings

- ◆ Lightweight titanium low friction rings
- ◆ Non-corrosive and inert, ideal for use in carbon laminate sailcloth
- ◆ Versatile utility solid ring
- ◆ Numerous uses on-board, barber hauler and sheet leads, purchase systems, bridles, clew and reefing rings and blocks
- ◆ Available in 4 sizes



Part No.	Bore Dia. mm	Overall Dia. mm	Overall Width mm	Safe working load kg	UOM
AQM5107	7	16	6	740	Each
AQM5110	10	22	8	4300	Each
AQM5115	15	35	11	4800	Each
AQM5120	20	44	17	5700	Each

Gransegel Cleats

- ◆ An alternative to the popular clamcleat leech line cleats
- ◆ Gransegel design has the unique feature of fitting compactly around the sail leech
- ◆ It is a compact and lightweight fitting.



Part No.	Leech Line Size mm	Length mm	Pack Qty
A054	1.5 - 2	29	100
A055	1.5 - 4	44	100
A059	2 - 4	58	50

Regular Cleats

- ◆ Injection moulded in nylon
- ◆ Rivets and back plate included



Part No.	Leech Line Size mm	Length mm	Pack Qty
A062	1.5 - 3.0	60	100



Clamcleat® Sail Cleats

◆ A deceptively simple ridged 'V' groove holds ropes firmly, yet is devoid of any parts to break or seize. It allows the immediate release of the rope by a short upward and backward pull. Most sail cleats can be sewn or riveted

Leech Line Cleats

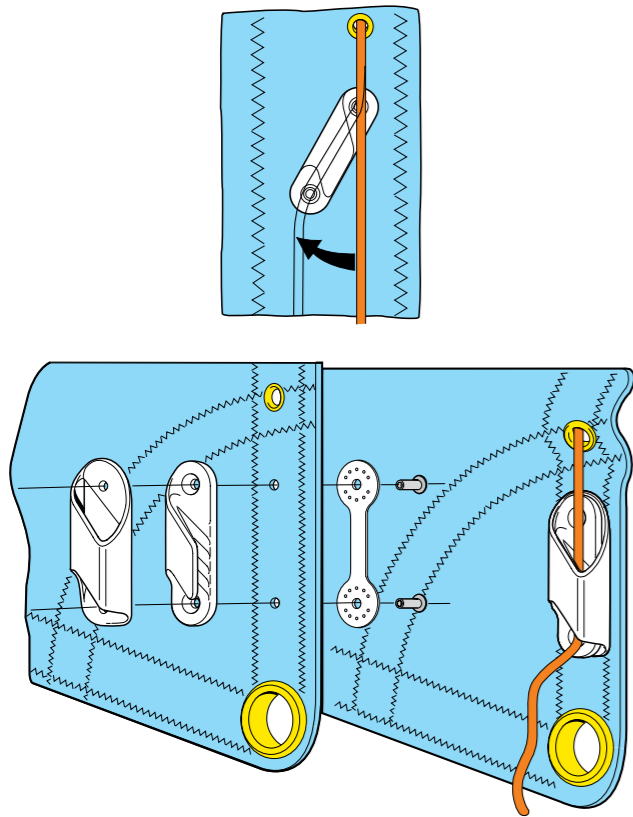

Part No.	Colour / Finish	Material	Rope Dia mm	Pack Qty
CL212	White	Nylon	2 - 5	10
CL212A	White	Nylon	-	10
CL212BP	White	Nylon	-	10
CL212BPB	Black	Nylon	-	10
Pack includes cleat, backplate and rivets				
CL212PR	White	Nylon	2 - 5	10



Part No.	Colour / Finish	Material	Rope Dia mm	Pack Qty
CL214W	White	Nylon	2 - 5	10
Pack includes cleat, backplate and rivets				
CL214WPR	White	Nylon	2 - 5	10



Part No.	Colour / Finish	Material	Rope Dia mm	Pack Qty
CL221	White	Nylon	2 - 5	10

Sail Line Cleats

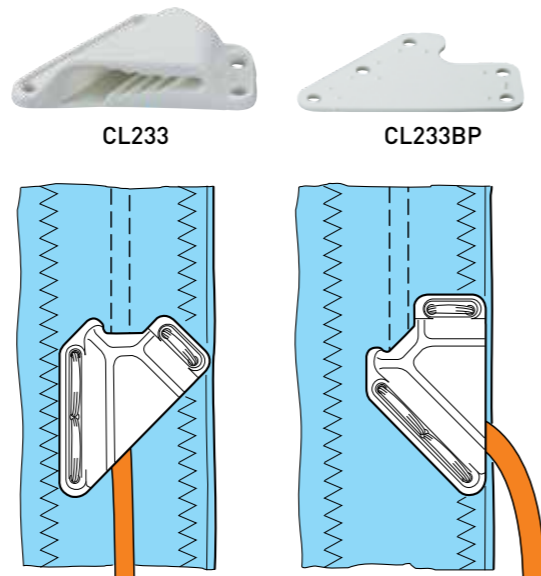

Part No.	Colour / Finish	Material	Rope Dia mm	Pack Qty
CL233	White	Nylon	2 - 6	10
CL233BP	White	Nylon	-	10

Racing Sail Line Cleats

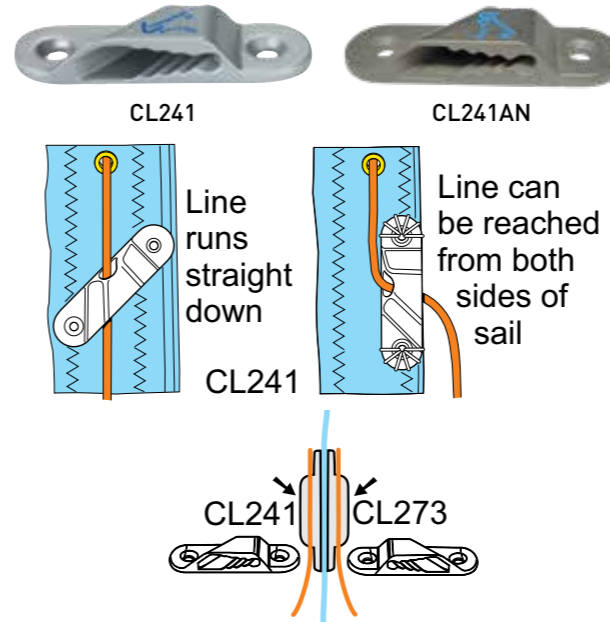

Part No.	Colour / Finish	Material	Rope Dia mm	Pack Qty
CL241	Silver	Aluminium	3 - 6	10
CL241AN	Hard Anodised	Aluminium	3 - 6	10
Pack includes cleat and backplate				
CL241ANP	Hard Anodised	Aluminium	3 - 6	10
Pack includes cleat, backplate and rivets				
CL241PR	Silver	Aluminium	3 - 6	10

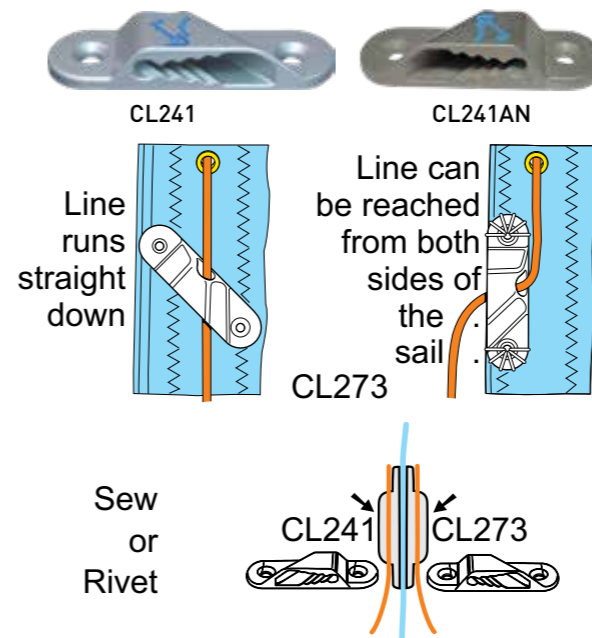

Part No.	Colour / Finish	Material	Rope Dia mm	Pack Qty
CL273	Silver	Aluminium	3 - 6	10
CL273AN	Hard Anodised	Aluminium	3 - 6	10
Pack includes cleat and backplate				
CL273ANP	Hard Anodised	Aluminium	3 - 6	10
Pack includes cleat, backplate and rivets				
CL273PR	Silver	Aluminium	3 - 6	10

Sail Edge Cleats

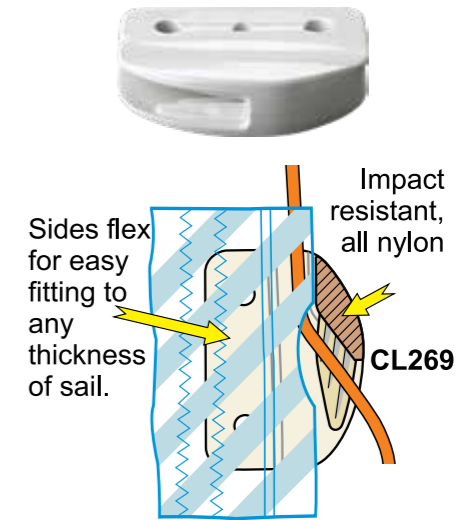

Part No.	Colour / Finish	Material	Rope Dia mm	Pack Qty
CL269	White	Nylon	2 - 4	10
Pack includes cleat and rivets				
CL269R	White	Nylon	2 - 4	10

Racing Sail Edge Cleats

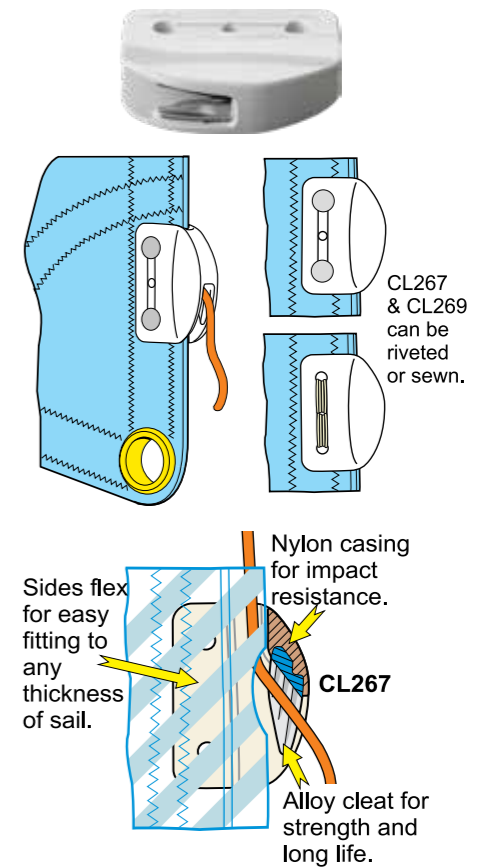

Part No.	Colour / Finish	Material	Rope Dia mm	Pack Qty
CL267	White	Aluminium & Nylon	2 - 4	10
Pack includes cleat, case and rivets				
CL267R	White	Aluminium & Nylon	2 - 4	10



Clamcleat® Cub



Part No.	Colour / Finish	Material	Rope Dia mm	Pack Qty
CL232	Black	Nylon	3 - 6	10

Clamcleat® Auto-Release Cleats

◆ Flips up to release the rope when a set load is exceeded. Easily re-set or adjusted for different release loads, even out on the water.



Part No.	Colour / Finish	Material	Rope Dia mm	Pack Qty
CL257	Silver / Black	Aluminium & Acetal	4 - 6	10

Clamcleat® Bollard Cleats



CL208



CL210

Part No.	Colour / Finish	Material	Rope Dia mm	Pack Qty
CL208	Black	Nylon	6 - 10	5
CL210	Black	Nylon	10 - 16	5

Clamcleat® Jamming Cleats



CL202



CL206



CL207

Part No.	Colour / Finish	Material	Rope Dia mm	Pack Qty
CL202	Black	Nylon	6 - 10	10
CL206	Black	Nylon	6 - 10	10
CL207	Black	Nylon	6 - 10	10

Clamcleat® Accessories



CL214



CL815



CL819



CL817



CL818



CL819

Part No.	Colour / Finish	Material	Rope Dia mm	Pack Qty
CL814	Black	Acetal	3 - 6	10
CL815	Black	Acetal	3 - 6	10
CL816	Black & Silver	Nylon & Stainless Steel	3 - 6	10
CL817	Black & Silver	Nylon & Stainless Steel	3 - 6	10
CL818	Black	Polypropylene	-	10
CL819	Black	Polypropylene	-	10

Clamcleat® Cleats for Ropes to 8mm



CL209



CL215



CL215W



CL231



CL254



CL254AN



CL803

Part No.	Colour / Finish	Material	Rope Dia mm	Pack Qty
CL209	Black	Nylon	4 - 8	10
CL215	Black	Nylon	4 - 8	10
CL215W	White	Nylon	4 - 8	50
CL231	Black	Nylon	4 - 8	10
CL254	Silver	Aluminium	4 - 8	10
CL254AN	Hard Anodised	Aluminium	4 - 8	10
CL803	Black	Polypropylene	-	10

Clamcleat® Cleats for Ropes to 12mm



CL219



CL219AN



CL228



CL804

Part No.	Colour / Finish	Material	Rope Dia mm	Pack Qty
CL219	Silver	Aluminium	6 - 12	10
CL219AN	Hard Anodised	Aluminium	6 - 12	10
CL228	Black	Nylon	6 - 12	10
CL804	Black	Polypropylene	-	10

Clamcleat® Cleats for Ropes to 16mm



CL205



CL220



CL2245



CL805

Part No.	Colour / Finish	Material	Rope Dia mm	Pack Qty
CL205	Black	Nylon	10 - 16	10
CL220	Silver	Aluminium	12 - 16	10
CL2245	Silver	Stainless Steel	-	10
CL805	Black	Polypropylene	-	10

Clamcleat® Fine Line Cleats



CL213



CL214



CL258



CL258AN



CL259



CL259AN

Part No.	Colour / Finish	Material	Rope Dia mm	Pack Qty
CL213	Black	Nylon	2 - 5	10
CL214	Black	Nylon	2 - 5	10
CL258	Silver	Aluminium	3 - 6	10
CL258AN	Hard Anodised	Aluminium	3 - 6	10
Pack includes cleat and backplate				
CL258ANP	Hard Anodised	Aluminium	3 - 6	10
Pack includes cleat and backplate				
CL258PR	Silver	Aluminium	3 - 6	10
CL259	Silver	Aluminium	3 - 6	10
CL259AN	Hard Anodised	Aluminium	3 - 6	10
Pack includes cleat and backplate				
CL259ANP	Hard Anodised	Aluminium	3 - 6	10
Pack includes cleat and backplate				
CL259PR	Silver	Aluminium	3 - 6	10



Clamcleat® Fairlead Cleats

Part No.	Colour / Finish	Material	Rope Dia mm	Pack Qty
CL263	Black	Nylon	1 - 4	10
CL263W	White	Nylon	1 - 4	10
CL268	Silver	Aluminium	1 - 4	10
CL268AN	Hard Anodised	Aluminium	1 - 4	10
CL270	Silver	Aluminium	1 - 4	10
CL270AN	Hard Anodised	Aluminium	1 - 4	10
CL277	Silver	Aluminium	1 - 4	10
CL277AN	Hard Anodised	Aluminium	1 - 4	10
CL278	Silver	Aluminium	1 - 4	10
CL278AN	Hard Anodised	Aluminium	1 - 4	10
CL203	Black	Nylon	3 - 6	10
CL203W	White	Nylon	3 - 6	10
CL211MK1	Silver	Aluminium	3 - 6	10
CL211MK1AN	Hard Anodised	Aluminium	3 - 6	10
CL211MK1VB	Vibro	Aluminium	3 - 6	10
CL211MK2	Silver	Aluminium	3 - 6	10
CL211MK2AN	Hard Anodised	Aluminium	3 - 6	10
CL211MK2ANS2	Hard Anodised	Aluminium	3 - 6	10
CL211MK2S2	Hard Anodised	Aluminium	3 - 6	10
CL272	Black	Nylon	3 - 6	10
CL272W	White	Nylon	3 - 6	10
CL702	Silver	Aluminium	3 - 6	10
CL702AN	Hard Anodised	Aluminium	3 - 6	10
CL704	Silver	Aluminium	3 - 6	10
CL704AN	Hard Anodised	Aluminium	3 - 6	10



Clamcleat® Line-Lok

- ◆ Line Tensioners lock lines securely and are easy to release.
- ◆ Grips the line to resist being shaken loose - even in extreme conditions.
- ◆ Out-performs all existing plastic guy runners.
- ◆ Easy to rig, push up to tension and secure, pull lines apart to release - easy to use even when wearing thick mitts or gloves



Part No.	Colour / Finish	Material	Rope Dia. mm	Pack Qty
CL266	Black	Nylon	1 - 3	12
CL266G	Glow-in-the-Dark	Nylon	1 - 3	12
CL266W	White	Nylon	1 - 3	12
CL260	Black	Nylon	2 - 5	8
CL260G	Glow-in-the-Dark	Nylon	2 - 5	8
CL260W	White	Nylon	2 - 5	8
CL276	Black	Nylon	3 - 6	4
CL276G	Glow-in-the-Dark	Nylon	3 - 6	4
CL276W	White	Nylon	3 - 6	4
CL271	Black	Nylon	4 - 8	10
CL271G	Glow-in-the-Dark	Nylon	4 - 8	10
CL271W	White	Nylon	4 - 8	10

Clamcleat® Loop Cleats



Part No.	Colour / Finish	Material	Rope Dia mm	Pack Qty
CL223	Black	Nylon	3 - 6	10
CL223W	White	Nylon	3 - 6	10
CL234	Black	Nylon	6 - 11	10
CL234W	White	Nylon	6 - 11	10

Clamcleat® Insert Cleats

- ◆ CL712, CL175 and CL176 have been designed to snap-fit into a plastic moulding to combine the strength of an alloy cleat with the lower cost of a moulded component



Part No.	Colour / Finish	Material	Rope Dia mm	Pack Qty
CL712	Silver	Aluminium	2 - 5	10
CL716	Silver	Aluminium	3 - 4	10
CL715	Silver	Aluminium	3 - 5	10
CL243	Black	Nylon	3 - 6	10
Pack includes cleat, clamp, rubber backing piece and 2 screws				
CL243S5	Black	Nylon	3 - 6	10
CL710	Silver	Aluminium	3 - 6	10

Clamcleat® Windsurfing Cleats



Part No.	Colour / Finish	Material	Rope Dia mm	Pack Qty
CL248	Silver	Aluminium	3 - 5	10



Clamcleat® Micros & Mini Cleats



Part No.	Colour / Finish	Material	Rope Dia mm	Pack Qty
CL274	Black	Nylon	1 - 4	10 Pairs
CL274W	White	Nylon	1 - 4	10 Pairs
CL275	Silver	Aluminium	1 - 4	10 Pairs
CL275AN	Hard Anodised	Aluminium	1 - 4	10 Pairs
CL204	Black	Nylon	3 - 6	10
CL204W	White	Nylon	3 - 6	10
CL222	Silver	Aluminium	3 - 6	10
CL222AN	Hard Anodised	Aluminium	3 - 6	10
CL802	Black	Polypropylene	-	10
CL823	Black	Polypropylene	-	10

Clamcleat® Power Grip Cleats

- ◆ The Power Grip 1 is for single-handed use, allowing you to pull twice the load.
- ◆ Use the Power Grip 2 where even more pulling power and control is required. It is light, strong and easy to carry in your pocket.



Part No.	Colour / Finish	Material	Rope Dia mm	Pack Qty
CL249	Silver	Aluminium	3 - 6	50
CL249AN	Hard Anodised	Aluminium	3 - 6	50
CL261	Silver	Aluminium	3 - 6	10
CL262	Silver	Aluminium	3 - 6	10

Clamcleat® Cobra Cleats, Omega & Q-Lok



Part No.	Colour / Finish	Material	Rope Dia mm	Pack Qty
CL5001	Silver	Stainless Steel	3 - 4	20
CL255	Silver	Aluminium	3 - 6	10
CL255AN	Hard Anodised	Aluminium	3 - 6	10
CL264	Silver	Aluminium	4 - 6	10
CL264AN	Hard Anodised	Aluminium	4 - 6	10

Clamcleat® Roller Cleats



Part No.	Colour / Finish	Material	Rope Dia mm	Pack Qty
CL203WS1	White	Nylon	3 - 6	100
CL230	Silver	Aluminium	3 - 6	10
CL236	Silver	Aluminium	3 - 6	10
CL236AN	Hard Anodised	Aluminium	3 - 6	10
CL230AN	Hard Anodised	Aluminium	4 - 8	10
CL253	Silver	Aluminium	4 - 8	10
CL253AN	Hard Anodised	Aluminium	4 - 8	10

Clamcleat® Tube Cleats



Part No.	Colour / Finish	Material	Rope Dia mm	Pack Qty
CL244	Silver	Aluminium	3 - 5	10
CL235	Silver & Black	Aluminium & Nylon	3 - 6	20
CL265	Silver	Aluminium	4 - 8	10
CL265AN	Hard Anodised	Aluminium	4 - 8	10

Clamcleat® Side Entry Cleats



Part No.	Colour / Finish	Material	Rope Dia mm	Pack Qty
CL217MK1	Silver	Aluminium	3 - 6	10
CL217MK1AN	Hard Anodised	Aluminium	3 - 6	10
CL217MK2	Silver	Aluminium	3 - 6	10
CL217MK2AN	Hard Anodised	Aluminium	3 - 6	10
CL218MK1	Silver	Aluminium	3 - 6	10
CL218MK1AN	Hard Anodised	Aluminium	3 - 6	10
CL218MK2	Silver	Aluminium	3 - 6	10
CL218MK2AN	Hard Anodised	Aluminium	3 - 6	10

Clamcleat® Spring-Gate Cleats

- ◆ The red gate is flipped up by hand to keep the rope out of the cleat.



Part No.	Colour / Finish	Material	Rope Dia mm	Pack Qty
CL237	Black	Nylon	6 - 12	10
CL238	Silver	Aluminium	6 - 12	10
CL239	Black	Nylon	10 - 16	10
CL240	Silver	Aluminium	12 - 16	10



Clamcleat® Aero Cleats

- ◆ Aero bases allow the user to move a cleat along a rope – no tools required.
- ◆ Easy to rig and adjust by hand.

Part No.	Colour / Finish	Rope Dia mm	Pack Qty
CL82863	Nylon	3 - 4	10
CL82868	Aluminium & Nylon	3 - 4	10
CL82868AN	Aluminium & Nylon	3 - 4	10
CL82870	Aluminium & Nylon	3 - 4	10
CL82870AN	Aluminium & Nylon	3 - 4	10
CL82877	Aluminium & Nylon	3 - 4	10
CL82877AN	Aluminium & Nylon	3 - 4	10
CL82911	Aluminium & Nylon	3 - 4	10
CL82911AN	Aluminium & Nylon	3 - 4	10
CL82611AN	Aluminium & Nylon	4 - 6	10
CL82617	Aluminium & Nylon	4 - 6	10
CL82617AN	Aluminium & Nylon	4 - 6	10
CL82672	Nylon	4 - 6	10
CL82703	Nylon	4 - 6	10
CL82711	Aluminium & Nylon	4 - 6	10
CL82711AN	Aluminium & Nylon	4 - 6	10
CL82717	Aluminium & Nylon	4 - 6	10
CL82717AN	Aluminium & Nylon	4 - 6	10
CL82718	Aluminium & Nylon	4 - 6	10
CL82718AN	Aluminium & Nylon	4 - 6	10
CL82736	Aluminium & Nylon	4 - 6	10
CL82736AN	Aluminium & Nylon	4 - 6	10



Tylaska

MARINE & AEROSPACE

Tylaska Marine & Aerospace has been manufacturing premium performance sailing hardware for over 25 years. Tylaska's iconic trigger release shackles are well known amongst professional competitive sailors around the world as the best sailing shackle money can buy. Tylaska aims to replicate this impression with every new product designed.

Tylaska Marine & Aerospace offers a wide range of high quality stainless steel and aluminium sailing hardware all designed to offer extreme performance for critical applications.



 CR Snap Shackles	 Halyard Shackles	 Loose Bails	 Swageless Cones
 ParaGrip	 Press Locks	 Rope Bushings	 Self-Locking Lifting Hooks
 SP Shackles	 Spinnaker Pole Ends	 Spool Shackles	 Swivels
 T-Shackles	 TR Rigging Rings	 Plunger Pin Shackle	 Plunger Pin Lifting Hooks

The full range of Tylaska products are available from bainbridgeint.com

SL SuperLuff

- ◆ Coloured stitching for fast and easy identification
- ◆ Sewn construction – not heat welded
- ◆ Totally encapsulated high quality hard braid luff rope
- ◆ Made using Bainbridge Sailcloth
- ◆ Carefully controlled finished tape diameter to fit all types of headstay foils
- ◆ It's not just super tuff – it's **SuperLuff**

Custom SuperLuff tapes are available in colours and sizes to suit you project.

Please contact us with your specific requirements.

Stitch Colour Coding Key	Based on finished size
Yellow	4mm
Red	5mm
Green	6mm
Blue	7mm



SL SuperLuff • BOLT ROPES

○ WHITE

● BLACK

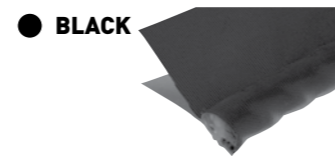
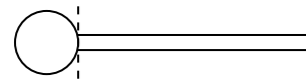

Part no.	Rope Dia: mm	Pre-finished Tape Width mm:	Finished size: mm	Cloth weight: sm oz	Reel length: m	UOM	Colours
L141	6	100	7	6	100	Metre	○
L142	6	80	7	6	100	Metre	○
L144	8	80	9	5	100	Metre	○
L145	4	80	5	6	100	Metre	○
L147	6	100	7	7	100	Metre	○
L149	4	80	5	6	100	Metre	●
L148	8	125	9	8 Dyneema®	100	Metre	○

SL SuperLuff • SINGLE PRE-STRETCHED

○ WHITE

● BLACK

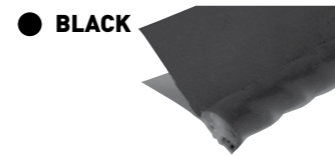
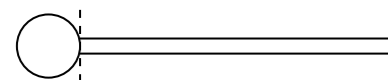

Part no.	Rope Dia: mm	Pre-finished Tape Width mm:	Finished size: mm	Cloth weight: sm oz	Reel length: m	UOM	Colours
L150	7	80	7.5	5	100	Metre	○
L151	7	100	8	7	100	Metre	○
L153	7	100	8	6	100	Metre	○●
L152	9	80	9.5	5	100	Metre	○

Please note: Reel lengths vary. Average reel 100m.

SL SuperLuff • SINGLE - LIGHT - POLYESTER

○ WHITE

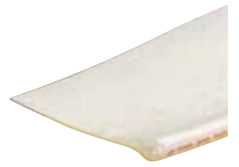
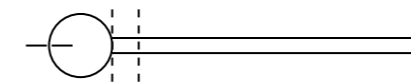

Part no.	Rope Dia: mm	Pre-finished Tape Width mm:	Finished size: mm	Cloth weight: sm oz	Reel length: m	UOM	Colours
L401LT	4	100	5	6	100	Metre	○
L402LT	5	100	6	6	100	Metre	○

SL SuperLuff • SINGLE - POLYESTER

○ WHITE

● CREAM

● BLACK

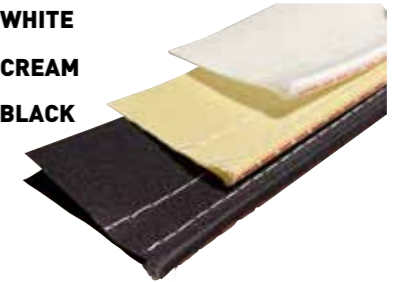
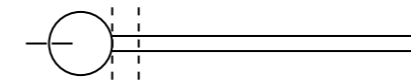

Part no.	Rope Dia: mm	Pre-finished Tape Width mm:	Finished size: mm	Cloth weight: sm oz	Reel length: m	UOM	Colours
L400	3	100	4	7	100	Metre	○
L401	4	100	5	7	100	Metre	○●●
L402	5	100	6	7	100	Metre	○●●
L403	6	100	7	7	100	Metre	○●●

SL SuperLuff • SINGLE RIPSTOP

● GREY

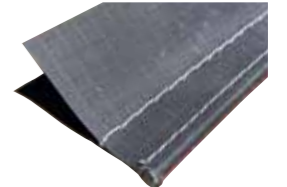
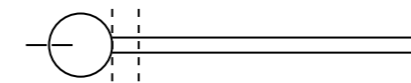

Part no.	Rope Dia: mm	Pre-finished Tape Width mm:	Finished size: mm	Cloth weight: sm oz	Reel length: m	UOM	Colours
L401GYP	4	100	5	6 HSXP Ripstop	100	Metre	●
L402GYP	5	100	6	6 HSXP Ripstop	100	Metre	●
L403GYP	6	100	7	6 HSXP Ripstop	100	Metre	●

SL SuperLuff • SINGLE PTFE

○ PTFE

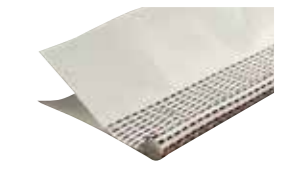
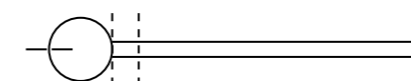

Part no.	Rope Dia: mm	Pre-finished Tape Width mm:	Finished size: mm	Cloth weight: sm oz	Reel length: m	UOM	Colours
L401T	4	100	5	8 PTFE	20/100	Metre	○
L402T	5	100	6	8 PTFE	20/100	Metre	○
L403T	6	100	7	8 PTFE	20/100	Metre	○

SL SuperLuff • DOUBLE - LIGHT POLYESTER

○ WHITE

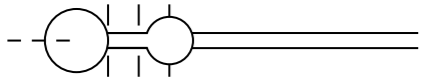

Part no.	Rope Dia: mm	Pre-finished Tape Width mm:	Finished size: mm	Cloth weight: sm oz	Reel length: m	UOM	Colours
L441LT	4	125	5	6	100	Metre	○
L442LT	5	125	6	6	100	Metre	○

SL SuperLuff • DOUBLE - POLYESTER

○ WHITE

● BLACK

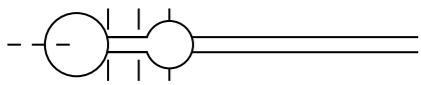
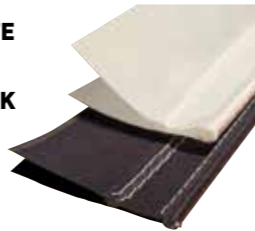

Part no.	Rope Dia: mm	Pre-finished Tape Width mm:	Finished size: mm	Cloth weight: sm oz	Reel length: m	UOM	Colours
L440	3	125	4	7	100	Metre	○
L441	4	125	5	7	100	Metre	○ ●
L442	5	125	6	7	100	Metre	○ ●
L443	6	125	7	7	100	Metre	○ ●

SL SuperLuff • DOUBLE - RIPSTOP

● GREY

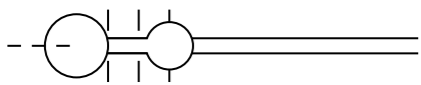
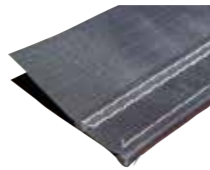

Part no.	Rope Dia: mm	Pre-finished Tape Width mm:	Finished size: mm	Cloth weight: sm oz	Reel length: m	UOM	Colours
L441GYP	4	125	5	6 HSXP Ripstop	100	Metre	○
L442GYP	5	125	6	6 HSXP Ripstop	100	Metre	○
L443GYP	6	125	7	6 HSXP Ripstop	100	Metre	○

SL SuperLuff • DOUBLE - VECTRAN®

○ WHITE

● GREY

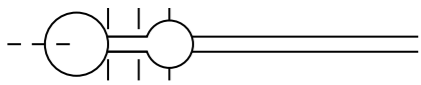
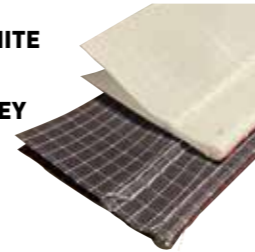

Part no.	Rope Dia: mm	Pre-finished Tape Width mm:	Finished size: mm	Cloth weight: sm oz	Reel length: m	UOM	Colours
L441V	4	125	5	6 HSXV Ripstop	100	Metre	○ ●
L442V	5	125	6	6 HSXV Ripstop	100	Metre	○ ●
L443V	6	125	7	6 HSXV Ripstop	100	Metre	○ ●

Please note: Reel lengths vary. Average reel 100m.

SL SuperLuff • DOUBLE - PTFE

○ PTFE

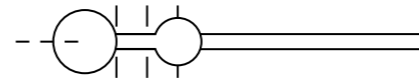
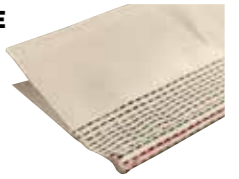

Part no.	Rope Dia: mm	Pre-finished Tape Width mm:	Finished size: mm	Cloth weight: sm oz	Reel length: m	UOM	Colours
L441T	4	125	5	8 PTFE	20/100	Metre	○
L442T	5	125	6	8 PTFE	20/100	Metre	○
L443T	6	125	7	8 PTFE	20/100	Metre	○

SL SuperLuff • DOUBLE - IMPERIAL

○ WHITE

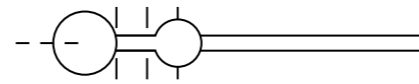

Part no.	Pre-finished Tape Width mm:	Finished size: inches	Cloth weight: sm oz	Reel length: m	UOM	Colours
LU605	125	5/32	6	100	Metre	○
LU606	125	3/16	6	100	Metre	○
LU607	125	7/32	6	100	Metre	○
LU608	125	1/4	6	100	Metre	○

Stitch Colour Coding Key	Based on finished size
Yellow	4mm
Red	5mm
Green	6mm
Blue	7mm

Stitch Colour Coding Key	Based on finished size
Orange	5/32"
Black	3/16"
Aqua	7/32"
Grey	1/4"

Luff Tape - Welded

- ◆ Ultra-sound welded luff tape
- ◆ 9 x 9 1100 Dtex polyester fabric
- ◆ High quality low stretch hard braid primary rope
- ◆ Lightweight monofilament secondary rope
- ◆ Consistent size and spacing for accuracy
- ◆ Heavier weave polyester tape for extra durability
- ◆ Packaged on a reel for ease of use around the loft



Part No.	Finished Size mm	Rope Construction	Colour	Reel Length m
LW441BK	5	Double	Black	100
LW441BK300	5	Double	Black	300
LW441WT	5	Double	White	100
LW441WT300	5	Double	White	300

Luff Foam

Foam used to reduce camber (draft) of roller furling sail when partially furled. When sewn on luff in a crescent moon shape there will be more cloth rolled out of the middle than the ends to help flatten the reefed sail



- ◆ Foam padding flattens sail when furled
- ◆ Flatter sail reduces heeling, makes boat easier to steer
- ◆ Easy to cut
- ◆ Does not absorb water
- ◆ Available only on full rolls
- ◆ 1XPE physically cross linked foam
- ◆ 33 kg/m³ density

Part No.	Roll Length m	Thickness mm	Width mm	UOM
LR001025	25	5	1000	Metre

Polyester Sailcloth Tape

- ◆ Hot slit to seal the edges
- ◆ Roll lengths are 100 metres nominal
- ◆ Jumbo rolls also available - approx 500m
- ◆ Available only on full rolls
- ◆ Colour: White

Part No.	Width mm	Weight		UOM
		gsm	sm oz	
S40020	20	170	4	Metre
S40025	25	170	4	Metre
S40030	30	170	4	Metre
S40040	40	170	4	Metre
S40045	45	170	4	Metre
S40050	50	170	4	Metre
S40060	60	170	4	Metre
S40063	63	170	4	Metre
S40070	70	170	4	Metre
S40075	75	170	4	Metre
S40080	80	170	4	Metre
S40100	100	170	4	Metre
S40125	125	170	4	Metre
S40150	150	170	4	Metre
S50025	25	215	5	Metre
S50040	40	215	5	Metre
S50050	50	215	5	Metre
S50060	60	215	5	Metre
S50063	63	215	5	Metre
S50070	70	215	5	Metre
S50075	75	215	5	Metre
S50080	80	215	5	Metre
S50090	90	215	5	Metre
S50100	100	215	5	Metre
S50120	120	215	5	Metre
S50125	125	215	5	Metre
S50350	350	215	5	Metre
S60040	40	255	6	Metre
S60050	50	255	6	Metre
S60060	60	255	6	Metre
S60063	63	255	6	Metre
S60070	70	255	6	Metre
S60075	75	255	6	Metre
S60080	80	255	6	Metre
S60090	90	255	6	Metre
S60100	100	255	6	Metre
S60120	120	255	6	Metre
S60125	125	255	6	Metre
S60150	150	255	6	Metre
S60200	200	255	6	Metre
S60230	230	255	6	Metre
S60250	250	255	6	Metre
S60300	300	255	6	Metre



Part No.	Width mm	Weight		UOM
		gsm	sm oz	
S70050	50	300	7	Metre
S70060	60	300	7	Metre
S70063	63	300	7	Metre
S70070	70	300	7	Metre
S70075	75	300	7	Metre
S700795	79.5	300	7	Metre
S70080	80	300	7	Metre
S70090	90	300	7	Metre
S70095	95	300	7	Metre
S70100	100	300	7	Metre
S70120	120	300	7	Metre
S70125	125	300	7	Metre
S70150	150	300	7	Metre
S70175	175	300	7	Metre
S70250	250	300	7	Metre
S80040	40	343	8	Metre
S80050	50	343	8	Metre
S80060	60	343	8	Metre
S80063	63	343	8	Metre
S80070	70	343	8	Metre
S80075	75	343	8	Metre
S80080	80	343	8	Metre
S80090	90	343	8	Metre
S80100	100	343	8	Metre
S80120	120	343	8	Metre
S80125	125	343	8	Metre
S80150	150	343	8	Metre
S80175	175	343	8	Metre
S80200	200	343	8	Metre
S80250	250	343	8	Metre

Jumbo Rolls

- ◆ Rolls 500m long. Marked every 100m

Part No.	Width mm	Weight		UOM
		gsm	sm oz	
S50080L	80	215	5	Metre
S60080L	80	255	6	Metre
S60100L	100	255	6	Metre
S60125L	125	255	6	Metre
S70100L	100	300	7	Metre
S70125L	125	300	7	Metre

PTFE Tape

- ◆ Profile PTFE yarns are woven into fabric to reduce friction when used in the manufacture of luff tapes
- ◆ Cut lengths available on request
- ◆ Non-fray selvage edge
- ◆ All rolls are approximately 20m or 100m



Part No.	Width mm	Weight		Metres Per Roll
		gsm	sm oz	
S80080T	80	343	8	100
S80080T20	80	343	8	20
S80100T	100	343	8	100
S80100T20	100	343	8	20
S80125T	125	343	8	100
S80125T20	125	343	8	20

Dyneema® Slit Tape

- ◆ 1000 Denier Dyneema® yarns are woven into fabric to reduce friction when used in the manufacture of luff tapes
- ◆ Dyneema® increases strength and reduces friction
- ◆ Can be used for batten chafe on full length pockets
- ◆ Low friction, high strength ideal for additional reinforcing at wear points on groove luff mainsails and One Design sails, i.e cunningham, batten pockets and headboard
- ◆ All white finish
- ◆ Non-fray selvage edge
- ◆ All rolls are approximately 20m or 100m
- ◆ Exclusive to Bainbridge



Part No.	Width mm	Weight		UOM
		gsm	sm oz	
S80125SP	125	343	8	100
S80125SP20	125	343	8	20

5-8oz Classic Polyester Coloured Sailcloth Tape

- ◆ These tapes are manufactured from Bainbridge polyester sailcloth
- ◆ Hot slit to seal the edges
- ◆ Available only on full rolls



Width mm	Cream	Tan	Weight		UOM
			gsm	sm oz	
50	-	S50050TN	215	5	Metre
63	-	S50063TN	215	5	Metre
63	S60063CR	S60063TN	255	6	Metre
75	S60075CR	S60075TN	255	6	Metre
80	S60080CR	S60080TN	255	6	Metre
100	S60100CR	S60100TN	255	6	Metre
75	S70075CR	S70075TN	300	7	Metre
80	S70080CR	S70080TN	300	7	Metre
100	S70100CR	S70100TN	300	7	Metre
125	S70125CR	S70125TN	300	7	Metre
100	S80100CR	S80100TN	343	8	Metre
125	S80125CR	S80125TN	343	8	Metre

Polyester Black Sailcloth Tape

- ◆ These tapes are manufactured from Bainbridge polyester sailcloth
- ◆ Hot slit to seal the edges
- ◆ Available only on full rolls
- ◆ Other colours and widths available on request



Part No.	Width mm	Weight		UOM
		gsm	sm oz	
S60050BK	50	255	6	Metre
S60063BK	63	255	6	Metre
S60080BK	80	255	6	Metre
S60100BK	100	255	6	Metre
S70075BK	75	300	7	Metre
S70100BK	100	300	7	Metre
S70125BK	125	300	7	Metre

4oz Polyester Coloured Sailcloth Tape

- ◆ These tapes are manufactured from Bainbridge polyester sailcloth
- ◆ Hot slit to seal the edges
- ◆ All rolls are 100 metres nominal
- ◆ Available only on full rolls



Width mm	Black	Blue	Green	Red	Weight		UOM
					gsm	sm oz	
25	S40025BK	S40025BU	S40025GR	S40025RD	170	4	Metre
30	S40030BK	-	-	-	170	4	Metre
40	S40040BK	S40040BU	S40040GR	S40040RD	170	4	Metre
50	S40050BK	S40050BU	S40050GR	S40050RD	170	4	Metre
60	S40060BK	S40060BU	S40060GR	S40060RD	170	4	Metre
63	S40063BK	-	-	-	170	4	Metre
75	S40075BK	S40075BU	S40075GR	S40075RD	170	4	Metre
80	S40080BK	S40080BU	-	S40080RD	170	4	Metre
100	S40100BK	S40100BU	-	S40100RD	170	4	Metre
125	S40125BK	-	-	-	170	4	Metre



4oz Folded Polyester Coloured Sailcloth Tape

- ◆ Bainbridge polyester sailcloth
- ◆ Hot slit to seal the edges
- ◆ All roll lengths are 100m
- ◆ Centre folded

Tape Width mm	Folded Width mm	Black	Blue	Green	Red	Weight		UOM
						gsm	sm oz	
25	12.5	S40025BKF	S40025BUF	S40025GRF	S40025RDF	170	4	Metre
40	20	S440040BKF	S40040BUF	S40040GRF	S40040RDF	170	4	Metre
50	25	S40050BKF	S40050BUF	S40050GRF	S40050RDF	170	4	Metre
100	50	S40100BKF	S40100BUF	S40100GRF	S40100RDF	170	4	Metre

Nylon Coloured Spinnaker Tape

- ◆ Other widths can be supplied - please enquire
- ◆ Hot slit to seal the edges
- ◆ All rolls are 100 metres nominal
- ◆ Available only on full rolls



Width mm	Green	Red	White	Weight		UOM
				gsm	sm oz	
25	T025GR	T025RD	T025WT	170	4	Metre
40	T040GR	T040RD	T040WT	170	4	Metre
50	T050GR	T050RD	T050WT	170	4	Metre
60	T060GR	T060RD	T060WT	170	4	Metre
75	T075GR	T075RD	T075WT	170	4	Metre
80	T080GR	T080RD	T080WT	170	4	Metre

Folded Polyester Tape

- ◆ These tapes are manufactured from Bainbridge polyester sailcloth
- ◆ Hot slit to seal the edges
- ◆ All roll lengths are 100 metres nominal
- ◆ Centre folded and wound onto spool for ease of use in a sail loft
- ◆ Folded to order



Part No.	Tape Width mm	Folded Width mm	Weight		UOM
			gsm	sm oz	
S40025F	25	12.5	170	4	Metre
S40040F	40	20	170	4	Metre
S40050F	50	25	170	4	Metre
S40060F	60	30	170	4	Metre
S40063F	63	31.5	170	4	Metre
S40080F	80	40	170	4	Metre
S50050F	50	25	215	5	Metre
S50060F	60	30	215	5	Metre
S50063F	63	31.5	215	5	Metre
S50080F	80	40	215	5	Metre
S50090F	90	45	215	5	Metre
S50100F	100	50	215	5	Metre

Part No.	Tape Width mm	Folded Width mm	Weight		UOM
			gsm	sm oz	
S60040F	40	20	255	6	Metre
S60050F	50	25	255	6	Metre
S60060F	60	30	255	6	Metre
S60063F	63	31.5	255	6	Metre
S60075F	75	37.5	255	6	Metre
S60080F	80	40	255	6	Metre
S60100F	100	50	255	6	Metre
S60120F	120	60	255	6	Metre
S60125F	125	62.5	255	6	Metre
S70060F	60	30	300	7	Metre
S70070F	70	35	300	7	Metre
S70080F	80	40	300	7	Metre
S70100F	100	50	300	7	Metre
S70120F	120	60	300	7	Metre
S70125F	125	62.5	300	7	Metre

See page 83 for Tell Tales and page 84 for Nylon Spinnaker Repair Tape

Nicopress Sleeves - Tools

- ◆ The finest and most accurate hand-closing tools for Nicopress sleeves



Part No.	Length mm	Type	Use With	UOM
C962N	51	64CGMP	B544N-B546N	Each

Stainless Steel Thimbles

- ◆ Solid thimbles are manufactured from heavy gauge type 316 stainless steel
- ◆ Chemically cleaned and/or electropolished
- ◆ Minimum distortion, maximum strength
- ◆ Long lasting appearance



B133 - B135

B153 - B158

Part No.	External Length mm	Inside Dia. mm	Style	Pack Qty
B133	24	10	Split	50
B134	26	12	Split	50
B135	32	14	Split	50
B136	39	16	Split	50
B137	45	20	Split	25
B138	51	22	Split	25
B140	59	25	Split	25
B153	28	12	Solid	50
B154	33	15	Solid	25
B155	36	18	Solid	25
B156	48	20	Solid	25
B158	56	24	Solid	25

Nicopress Sleeves

- ◆ Zinc plated copper sleeves/ferrules
- ◆ Manufactured to imperial sizes
- ◆ Use closing tool C962N



Part No.	Description	Wire Size mm	Pack Qty
B542N	Nicopress Sleeves - Zinc Plated Copper	2	100
B543N	Nicopress Sleeves - Zinc Plated Copper	2.5	100
B544N	Nicopress Sleeves - Zinc Plated Copper	3	100
B545N	Nicopress Sleeves - Zinc Plated Copper	4	100
B546N	Nicopress Sleeves - Zinc Plated Copper	4.5	100

Copper Sleeves

- ◆ Plain copper sleeves / ferrules
- ◆ Manufactured to imperial sizes
- ◆ Use Nicopress closing tool



Part No.	Description	Wire Size mm	Pack Qty
B540	Copper Sleeves	2	100
B541	Copper Sleeves	2.5	100
B542	Copper Sleeves	3	100
B543	Copper Sleeves	3.5	100
B544	Copper Sleeves	4	100
B546	Copper Sleeves	5	100
B547	Copper Sleeves	6	100
B549	Copper Sleeves	8	100



Sailman Rings

- ◆ Designed and made with the expected Bainbridge quality and standards
- ◆ Manufactured from 316L stainless steel
- ◆ Range of 10 sizes from 10 to 55mm
- ◆ Dedicated closing dies, though many ring sizes work with existing dies

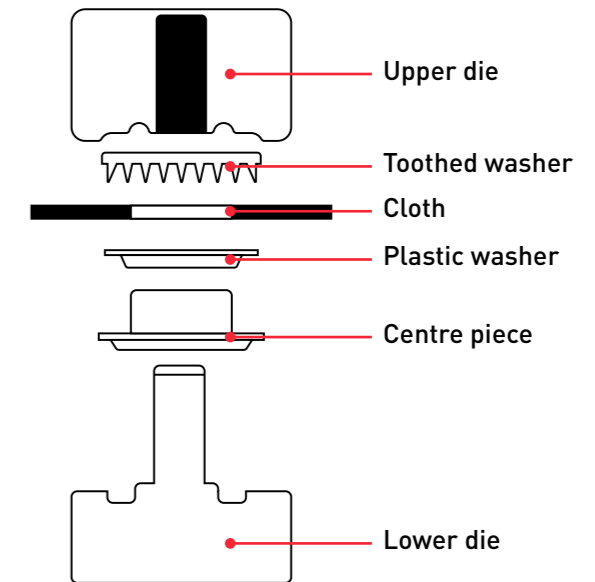

Diagram depicts larger size dies. Smaller dies differ in appearance.

Part No	Diameter Data		Force and Load data				Closing Dies Compatible with		
	Inside Dia - mm	Hole punch Dia - mm	Press force on Dies - tonnes	Yield Force kg	Max Load kg	Unit Weight g	UOM	Bainbridge Part No	Other
D510	10	11	1.5	150	310	6	Each	CD510	ER / SR
D512	12	13	1.7	320	660	9	Each	CD512	ER / SR
D514	14	15	2.5	860	1780	13	Each	CD514	ER / SR
D517	17	19	10	920	2150	20	Each	CD517	ER
D520	20	22	12	790	2525	30	Each	CD520	ER / SR
D525	25	28	15	1250	3340	36	Each	CD525	ER / SR
D530	30	32	20	1500	5800	66	Each	CD530	ER
D535	35	38	22	1800	6970	81	Each	CD535	ER / SR
D545	45	47	25	3030	9310	146	Each	CD545	ER / SR
D555	55	57	30 - 2 stage	3200	15050	237	Each	CD555	ER / SR

Inox Pressed Rings

The Bainbridge International Inox Ring System has been in constant worldwide use by top sailmakers for many years because it offers high strength and corrosion resistance with ease of setting and a range of attachments to simplify and enhance sail attachment points.



- ◆ Manufactured from type 316 stainless steel, and injection moulded nylon
- ◆ Liners and pins are passivated to reduce risk of staining
- ◆ Liners are seamless for maximum strength
- ◆ Range of colours to permit the use of house colours and sail identification
- ◆ Finely pointed pins penetrate between the sailcloth fibres and do not cut the fabric

- ◆ Nylon ring gives chafe-free contact with sailcloth
- ◆ When set, the pins are locked through the sailcloth and into the opposite face of the ring providing double shear strength
- ◆ Range of high strength clew attachments available
- ◆ Excellent internal profile for attachment of sheets
- ◆ Often used as cunningham

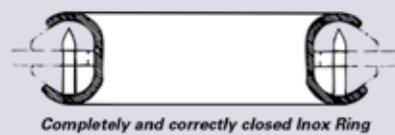

Setting Inox Rings

The design build-up will allow the maximum strength of the ring to be developed. In lighter sails, it is not imperative to use this design thickness. Inox Rings should always be set on the correct tools. Damage to the dies can be caused by excessive pressure. Always start with the pressure valve unloaded and build up from zero to the desired pressure. Tools should be polished if wear becomes evident. Light lubrication of the working faces is recommended. Rings must be closed with the pinned section and liner facing up in the base of the closing tool. Surrounding cloth should be supported while ring is being closed.

Part No.	Cloth build-up thickness: mm	Hole Punch Size: mm	Hole Punch Part No.	Closing Tool Part No.	Suggested closing force tonnes	Hole size when set: mm
D208	0.7	12.7	C108	C408	6 - 9	10
D207	0.6	15.9	C110	C407	6 - 8	12
D209	1.6	19.0	C112	C409	9 - 11	15
D210	2.1	22.2	C114	C410	11 - 15	20
D211	2.5	28.6	C117	C411	13 - 16	25
D212	2.8	34.9	C119	C412	18 - 20	30
D213	3.1	38.1	C120	C413	19 - 23	35
D214	3.3	44.5	C122	C414	20 - 25	40

Part No.	Set Hole Diameter mm	Colour	Pack Qty
D208B	10	Black	50
D208N	10	Blue	50
D207B	12	Black	50
D207N	12	Blue	50
D207R	12	Red	50
D209B	15	Black	50
D209N	15	Blue	50
D209R	15	Red	50
D209W	15	White	50
D210B	20	Black	50
D210N	20	Blue	50
D210R	20	Red	50
D210W	20	White	50
D211B	25	Black	25
D211G	25	Green	25
D211N	25	Blue	25
D211R	25	Red	25
D211W	25	White	25
D212B	30	Black	25
D213B	35	Black	25
D214B	40	Black	10

Liners Only

- ◆ Passivated to reduce risk of staining
- ◆ Seamless for maximum strength
- ◆ Stainless steel



Part No.	Set Hole Diameter mm	UOM
D207A	12	Each
D208A	10	Each
D209A	15	Each
D210A	20	Each
D211A	25	Each
D212A	30	Each
D213A	35	Each
D214A	40	Each

Inox Pressed Rings – Closing Tools

- ◆ Suitable for most presses
- ◆ All except C408 can be used with Enerpac-Nautilus pull down presses by removing the centre post



Part No.	To be Used With	UOM
C407	D207	Each
C408	D208	Each
C409	D209	Each
C410	D210	Each
C411	D211	Each
C412	D212	Each
C413	D213	Each
C414	D214	Each

Inox Outhaul Attachments

- ◆ Type 316 Stainless steel strap provides ultra-high strength attachment to inox rings
- ◆ Minimum offset permits ring to be very low in the sail.
- ◆ Low friction injection moulded slide with encapsulated bail.
- ◆ 'C' products feature reduced bail thickness of 2mm for use in modern dinghy booms with very narrow groove opening.



Part No.	Set Hole Diameter mm	To be used with	Pack Qty
B2075	7.9	D207	10
B2075C	7.9	D207	10
B2095	7.9	D209	10
B2095C	7.9	D209	10
B2105	7.9	D210	10
B2076	9.3	D207	10
B2096	9.3	D209	10
B2106	9.3	D210	10
B2108	12	D210	10
B2118	12	D211	10

Stainless Steel - Round Rings

- ◆ Manufactured from type 316 stainless steel, which is chemically passivated after welding to reduce the risk of staining
- ◆ TIG welded maximising strength
- ◆ Small diameter rings with the same size bar diameter will deform at a higher load, although both will have similar tensile strength



Part No.	Inside Dia. mm	Bar Dia. mm	Safe Working Load kg	Pack Qty
B114	20	4	1250	10
B204	25	3	150	10
B214	25	5	300	10
B227	25	6	800	10
B118	30	5	300	10
B117	30	6	600	10
B228	30	8	1000	10
B119	40	6	400	10
B219	40	8	750	10
B229	40	9	1300	10
B121	45	8	900	10
B220	50	8	550	10
B221	50	9	1000	10
B225	50	11	2300	10

Nickel Plated Steel - O Rings

- ◆ Economy rings designed for low load applications
- ◆ Use on bags and soft side of luggage



Part No.	Inside Dia. mm	Bar Dia. mm	Pack Qty
B191	25	5	10

Stainless Steel - D Rings

- ◆ Manufactured from type 316 stainless steel
- ◆ Chemically and passivated after welding to reduce the risk of staining
- ◆ TIG welded maximises strength



Part No.	Inside Dia. mm	Bar Dia. mm	Safe Working Load kg	Pack Qty
B170	25	5	300	10
B171	31	5	150	10
B172	40	5	500	10
B174	50	6	900	10

Nickel Plated Steel - D Rings

- ◆ Economy 'D' rings designed for low load applications
- ◆ Use on bags and soft side of luggage



Part No.	Inside Dia. mm	Bar Dia. mm	Pack Qty
B196	25	4	10
B197	38	5	10

Stainless Steel - Triangles

- ◆ Bainbridge triangles are manufactured from type 316 stainless steel, which is cleaned and passivated after welding to reduce the risk of staining
- ◆ TIG welded to maximise strength



Part No.	Inside Dia. mm	Bar Dia. mm	Safe Working Load kg	Pack Qty
B127	51	63	500	10

Stainless Steel - Maxi Rings

- ◆ Bainbridge maxi rings are manufactured from type 316 stainless steel, which is cleaned and passivated after welding to reduce the risk of staining
- ◆ TIG welded maximises strength
- ◆ Reinforcing bar reduces potential distortion under high load



Part No.	Inside Dia. mm	Bar Dia. mm	Safe Working Load kg	UOM
B229B	38	9.3	2600	Each
B225B	51	11.1	4000	Each
B226B	64	12.7	4500	Each
B218B	76	15.8	10000	Each



Part No.	Inside Dia. mm	Bar Dia. mm	Safe Working Load kg	UOM
B225BB	38	9.3	4000	Each
B226BB	51	11.1	4500	Each

Stainless Steel - Sail Rings

- ◆ Lighter and stronger than conventional equivalent welded rings
- ◆ Cast construction eliminates weld weak point
- ◆ Made from 17-4 stainless steel, higher SWL than type 316
- ◆ Elliptical cross-section and strengthening bar increases stiffness
- ◆ Can accommodate multiple sheets during sail or sheet point changes



Part No.	Size mm	Safe Working Load kg	UOM
B248	74 x 58 x 9.3 x 6.4	2000	Each
B250	92 x 72 x 10.5 x 7.2	3000	Each

Clew Pieces

- ◆ Made from 17-4 stainless steel a higher SWL than type 316
- ◆ Elliptical cross-section and strengthening bar increase stiffness
- ◆ Easy to web to sail
- ◆ Can accommodate multiple sheets while sailing or sheet point changes



Part No.	Inside Dia. mm	Bar Dia. mm	Safe Working Load kg	Weight: g	UOM
B123	51	7.9	850	99	Each
B126	96	12.7	3800	446	Each

PURE® Sheets - 100% Polypropylene Self-reinforced Composite Material

PURE® material provides both high stiffness and ultimate toughness combined with unique low density. Lightweight and stiff which makes the material interesting for a wide variety of applications where weight saving and energy absorption is desired.

- ◆ Ideal for membrane sail manufacture and sail reinforcement and chafe
- ◆ Extremely strong, even at very low temperatures
- ◆ Light weight, low density (Up to 50% lighter, compared to polycarbonate)
- ◆ Water resistant
- ◆ Easily stitchable
- ◆ Very high tear strength
- ◆ Standard sheet dimensions: 1200mm x 1200mm
- ◆ Other thicknesses & sheet sizes available on request

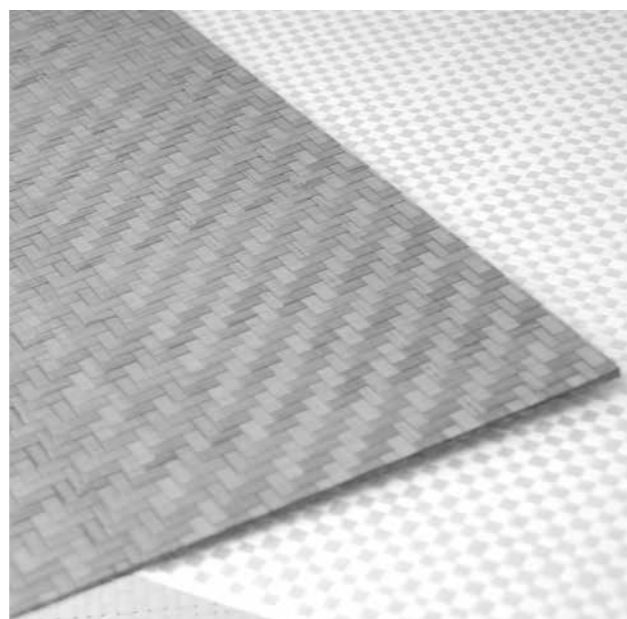

Part No	Description	Colour	Thickness mm	Sheet Size	UOM
FWPP03100	3 layer sheet	White	0.4	1200 x 1200	Each
FWPP03191	3 layer sheet	Grey	0.4	1200 x 1200	Each
FWPP06100	6 layer sheet	White	0.8	1200 x 1200	Each
FWPP06191	6 layer sheet	Grey	0.8	1200 x 1200	Each
FWPP09100	9 layer sheet	White	1.2	1200 x 1200	Each
FWPP09191	9 layer sheet	Grey	1.2	1200 x 1200	Each

* thickness is only estimated and for use as a guide

Aramid PSA Patch

- ◆ Ideal for lightweight corner patches and local reinforcement on laminate sails
- ◆ Onboard laminate sail repairs



Part No.	Description	Roll / Width mm	UOM
F7010Z00M	Aramid Patch Cloth - 137cm Adhesive backed	1370	Metre
J742	Adhesive Aramid Tape - 400 Denier Twaron®	50	Metre
J743	Adhesive Aramid Tape - 400 Denier Twaron®	75	Metre
J744	Adhesive Aramid Tape - 400 Denier Twaron®	102	Metre

Polyester Sailcloth with PSA

- ◆ Polyester sailcloth with a UV stable (non-yellowing) pressure sensitive adhesive coating with backing paper
- ◆ A comprehensive range of weights available
- ◆ Uses include: 2-ply, spreader and chafe patches, parts and repairs



Part No.	Weight		Roll Width cm	UOM
	gsm	sm oz		
FWP0400A	170	4	137	Metre
FWP0500A	215	5	137	Metre
FWP0600A	255	6	137	Metre
FWP0700A	300	7	137	Metre
FWP0800A	343	8	137	Metre
FWP0900A	400	9	137	Metre



PSA Acrylic

PSA Acrylic Solacryl is used to prevent UV radiation from attacking the headsail while a boat is moored. It is advisable to place a UV strip on its leech and foot. Once rolled up, the sail is completely protected from the harmful effects of the sun. Our PSA backing greatly increases efficiency during application, therefore reduces time and labour cost when fitting acrylic UV covers.

- ◆ Composition: 100% Solacryl Acrylic
- ◆ Finish: Special marine treatment
- ◆ High quality appearance of a traditional cover
- ◆ Acrylic yarns give excellent UV stability
- ◆ 100% solution dyed for consistent, rich, non-fade colours
- ◆ Fungi, bacteria and insect resistant
- ◆ Rot proof, oil and grease resistant



Part No.	Weight gsm	Roll Width cm	Colour	UOM
F83500100A	355	150	White	Metre
F83500206A	355	150	Captain Navy	Metre
F83500230A	355	150	Mid Blue	Metre
F83500300A	355	150	Silver	Metre
F83500450A	355	150	Black	Metre

Please note: Colour representations shown are the closest approximate match permissible by print process. Customers should be aware that the colour of products will alter in appearance to the eye by the light and environment, e.g. bright blue environments will change yellow to greener shades.



PSA Polyester

- ◆ Odyssey® PSA is an acrylic coated, 100% woven polyester with pressure sensitive adhesive suitable for many indoor or outdoor applications
- ◆ Mildew and UV resistant
- ◆ Uses: Boat cover repairs, reinforcement and UV roller furling covers



Part No.	Roll L - m	Roll W - cm	Colour	UOM
F0808Z00Y	45.7	150	White	Metre
F0808Z18Y	45.7	150	Caribbean Blue	Metre
F0808Z75Y	45.7	150	Burgundy	Metre
F0808Z79Y	45.7	150	Royal Blue	Metre
F0808Z88Y	45.7	150	Silver Grey	Metre
F0808Z90Y	45.7	150	Harbour Blue	Metre
F0808Z97Y	45.7	150	Charcoal Grey	Metre

Monofilm PSA

- ◆ PSA polyester film with self adhesive backing material for boardsails repairs etc



Part No.	Roll Length m	Roll Width mm	Pack Qty
J872	45.7	50	Roll
J874	45.7	1370	Metre

Please note: Colour representations shown are the closest approximate match permissible by print process. Customers should be aware that the colour of products will alter in appearance to the eye by the light and environment, e.g. bright blue environments will change yellow to greener shades.

Polyester Monofilm

- ◆ Both clear and opaque white
- ◆ Light weight performance material
- ◆ Clear polyester films for boardsails and telltale windows
- ◆ Opaque white films for repeat pattern layouts



Part No.	Style	Roll Length m	Roll / Width mm	Thick-ness microns	Weight gsm	UOM
MYL175	Clear	50	1445	175	230	Metre
MYL250	Clear	40	1524	250	360	Metre
MYL35003	Opaque	30	1220	350	465	Metre

Polyester Film

- ◆ See-through polyester film for a light weight performance material for boardsails and telltale windows



Part No.	Roll Length m	Roll Width cm	Thickness mm	UOM
E078	45.7	137	0.12	Metre

Tell Tale Windows

- ◆ UV stabilised vinyl



Part No.	Style	Diameter mm]	Thickness mm/thou	Pack Qty
E210	Clear	225	0.5/20	10

Premium Polyester Insignia

- ◆ Silicone release paper with printed grid pattern
- ◆ Pressure sensitive adhesive (PSA)
- ◆ Uses include: Sail numbers, patching and logos
- ◆ Cut lengths available



Roll Width cm	Roll Length m	Weight with backing paper gsm	Weight without backing paper gsm	UOM
142	45.7	262	132	Metre

High Tack Polyester Insignia



Roll Width cm	Roll Length m	Weight with backing paper gsm	Weight without backing paper gsm	UOM
142	50	→300	→130	Metre

Premium Printable UV Coated Polyester Insignia

- ◆ Titanium dioxide pigment coating applied for the best UV protection
- ◆ Acrylic adhesive
- ◆ Works for most solvent digital inkjet printing



Roll Width cm	Roll Length m	Weight with backing paper gsm	Weight without backing paper gsm	UOM
137	45.72	270	156	Metre

Printable Polyester Insignia

- ◆ Good weather resistance
- ◆ Good performance with easy writing and printable surface on yacht sails



Roll Width cm	Roll Length m	Weight with backing paper gsm	Weight without backing paper gsm	UOM
137	45.72	319	167	Metre

Please note: Colour representations shown are the closest approximate match permissible by print process. Customers should be aware that the colour of products will alter in appearance to the eye by the light and environment, e.g. bright blue environments will change yellow to greener shades.

Insignia Draft Stripe & Tapes

- ◆ Draft / camber stripe Insignia tape
- ◆ Available in various colours & widths
- ◆ Sold on full rolls only
- ◆ Transition tape for laminate sails



Part No.	Roll Width mm	Roll Length m	Colour
J015BK	15	45.7	Black
J015BU	15	45.7	Blue
J015GY	15	45.7	Grey
J015OR	15	45.7	Orange
J015RD	15	45.7	Red
J015WT	15	45.7	White
J020BK	20	45.7	Black
J020BU	20	45.7	Blue
J020GY	20	45.7	Grey
J020OR	20	45.7	Orange
J020RD	20	45.7	Red
J020WT	20	45.7	White
J025BK	25	45.7	Black
J025BU	25	45.7	Blue
J025FP	25	45.7	Fluorescent Pink
J025FY	25	45.7	Fluorescent Yellow
J025GR	25	45.7	Green
J025GY	25	45.7	Grey
J025OR	25	45.7	Orange
J025RD	25	45.7	Red
J025WT	25	45.7	White

Part No.	Roll Width mm	Roll Length m	Colour
J040BK	40	45.7	Black
J040BU	40	45.7	Blue
J040GY	40	45.7	Grey
J040RD	40	45.7	Red
J040WT	40	45.7	White
J050BK	50	45.7	Black
J050BU	50	45.7	Blue
J050FP	50	45.7	Fluorescent Pink
J050FY	50	45.7	Fluorescent Yellow
J050GR	50	45.7	Green
J050GY	50	45.7	Grey
J050OR	50	45.7	Orange
J050RD	50	45.7	Red
J050WT	50	45.7	White
J060BK	60	45.7	Black
J060SL	60	45.7	Silver
J060WT	60	45.7	White
J075BK	75	45.7	Black
J075BU	75	45.7	Blue
J075GY	75	45.7	Grey
J075RD	75	45.7	Red
J075WT	75	45.7	White
J080WT	80	45.7	White
J100BK	100	45.7	Black
J100BU	100	45.7	Blue
J100GY	100	45.7	Grey
J100GR	100	45.7	Green
J100RD	100	45.7	Red
J100SL	100	45.7	Silver
J100WT	100	45.7	White
J125WT	125	45.7	White
J150BK	150	45.7	Black
J200WT	200	45.7	White
J250WT	250	45.7	White

AQUA MARINE

Sail Repair Patches

- ◆ Heavy duty PSA self adhesive sail repair patches
- ◆ Miscellaneous sizes suits most small to medium repairs
- ◆ Radiused edge helps reduce peel
- ◆ Available in 5 colours
- ◆ Suitable for all types of sailcloth including laminate, polyester and nylon
- ◆ Can be used as emergency repairs for sails, foul weather gear, seat cushions and boat covers
- ◆ Ideal for repairing batten pockets and also as chafing patch
- ◆ Bainbridge UK manufacture



AQM514BU AQM514RD AQM514WT



AQM514BK AQM514GY

Part No.	Colour	Pack Qty
AQM514BU	Blue	10
AQM514RD	Red	10
AQM514WT	White	10
AQM514BK	Black	10
AQM514GY	Grey	10

Circles & Tell Tale Patches

- ◆ Self adhesive insignia circles for reinforcement, protection or repair
- ◆ Various colours / sizes available

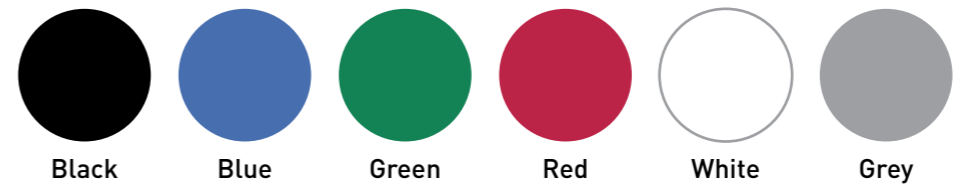

Size mm	Black	Blue	Green	Red	White	Grey	Pack Qty
25	SD002BK	SD002BU	SD002GR	SD002RD	SD002WT	SD002GY	10
50	SL002BK	SL002BU	SL002GR	SL002RD	SL002WT	SL002GY	10
100	SL003BK	SL003BU	SL003GR	SL003RD	SL003WT	SL003GY	10
150	SL004BK	SL004BU	SL004GR	SL004RD	SL004WT	SL004GY	10
200	SL006BK	SL006BU	SL006GR	SL006RD	SL006WT	SL006GY	10

AquaMarine Tell Tales

- ◆ Self adhesive oval insignia patch with wool tell tale
- ◆ Easy application

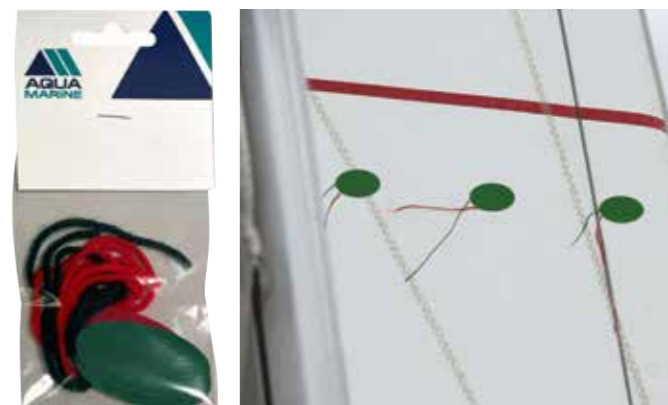

Part No.	Description	UOM / Pack Qty
AQMTT01	4 x red 4 x green	EACH
TT100BU	Bulk Pack Blue	100
TT100GR	Bulk Pack Green	100
TT100RD	Bulk Pack Red	100

Please note: Colour representations shown are the closest approximate match permissible by print process. Customers should be aware that the colour of products will alter in appearance to the eye by the light and environment, e.g. bright blue environments will change yellow to greener shades.

Nylon Repair Tape

- ◆ Instant repairs when you need it most
- ◆ Adheres instantly on contact
- ◆ Conforms to the shape of the sail
- ◆ Can be used for emergency repair to foul weather gear, seat cushions, boat covers and canvas
- ◆ Prevents sail chafe

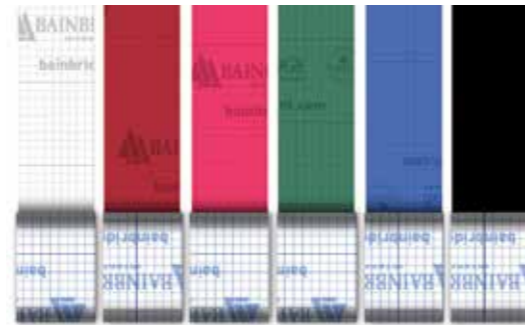

Part No.	Weight (gsm)	Size (mm x m)	Colour	UOM
FWN4501A	45	50 x 10	White	Roll
FWN4510A	45	50 x 10	Red	Roll
FWN4513A	45	50 x 10	Pink	Roll
FWN4550A	45	50 x 10	Green	Roll
FWN4560A	45	50 x 10	Royal Blue	Roll
FWN4599A	45	50 x 10	Black	Roll

Ocean Sail Repair Kit

Sturdy zip sailcloth holdall containing the following:

- ◆ 1 x General Purpose Kit Bag
- ◆ 1 x William Smith Palms No.11
- ◆ 1 pack of Sailmakers Needles 20 Assorted No. 14-19
- ◆ 5m of 12mm Standard Weight webbing
- ◆ 5m of 25mm Heavy Weight webbing
- ◆ 10m of 100mm Slit Sailcloth
- ◆ White Insignia Tape/Draft Stripe
- ◆ 2 x Awls
- ◆ 20 x Black Pushpins
- ◆ 1 x 15mm Double Sided Tape 50m
- ◆ 1 x Fiskars Scissors Lightweight 1005148
- ◆ 2 x Rings 30mm x 5mm Welded
- ◆ 1 x Waxed Sewing Thread
- ◆ 1 pack of Sail Repair Patches Assorted Sizes
- ◆ 1 x Twisted Whipping Twine



Part No.	Type	UOM
C980	Ocean Repair	Each

3M Adhesive Remover

- ◆ A specially blended solvent that provides easy cleanup of most types of adhesive and quickly removes waxes, road tars, grease, oil and similar materials
- ◆ Will not harm vinyl or fabrics when properly used
- ◆ Always try on a small area of similar material before use on a sail or cover
- ◆ Easy to apply
- ◆ Non-toxic
- ◆ Non-allergenic
- ◆ Much safer than acetone



Part No.	Liquid Measure (ml)	UOM
M040	946	Each

Please note: Colour representations shown are the closest approximate match permissible by print process. Customers should be aware that the colour of products will alter in appearance to the eye by the light and environment, e.g. bright blue environments will change yellow to greener shades.

Class Insignia

- ◆ Pre-cut class insignia
- ◆ Precision die cut from self-adhesive polyester fabric
- ◆ Supplied in pairs only



Class	Colour						UOM
	Black	Blue	Blue & Red	Green	Grey	Red	
470	INS017BK	INS017BU	-	-	-	INS017RD	Pair
470 Rhombus	-	-	-	-	-	INS470RD	Pair
Albacore	-	INS001BU	-	-	-	-	Pair
Europe	-	-	INS007BR	-	-	-	Pair
Finn	-	INS009BU	-	-	-	INS009RD	Pair
F18	INS018BK	-	-	-	-	-	Pair
Flying Fifteen	INS019BK	INS019BU	-	-	-	-	Pair
GP 14	INS023BK	INS023BU	-	-	-	-	Pair
Fireball	-	-	-	-	-	INS011RD	Pair
H-Boat	-	-	INS027B/R	-	-	-	Pair
ILAC Laser Rhombus	-	-	-	-	-	INS617RD	Pair
Kestrel	INS031BK	INS031BU	-	-	-	-	Pair
Merlin Rocket	INS033BK	-	-	-	-	-	Pair
Miracle	-	-	-	-	-	INS037RD	Pair
Mirror	INS039BK	-	-	-	-	-	Pair
Moody	INS041BK	INS041BU	-	-	-	-	Pair
OK	INS045BK	-	-	-	INS045GY	INS045RD	Pair
Optimist	INS047BK	INS047BU	-	-	INS047GY	INS047RD	Pair
Osprey	INS049BK	-	-	-	-	INS049RD	Pair
Pirate	-	-	-	-	-	INS051RD	Pair
Scorpion	INS055BK	INS055BU	-	-	-	INS055RD	Pair
Snipe	-	INS059BU	-	-	-	INS059RD	Pair
Solo	INS061BK	INS061BU	-	INS061GR	-	-	Pair
Topper	INS067BK	INS067BU	-	-	-	-	Pair
Wayfarer	-	-	-	-	-	INS071RD	Pair
Westerly	INS073BK	INS073BU	-	-	-	-	Pair
Yngling	-	INS075BU	-	-	-	-	Pair

Laser Class Computer Eights

- ◆ Available in black and red
- ◆ Specific Laser Class numbers

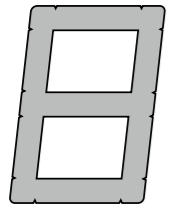

All numbers can be cut from the number '8'



ORDER EXAMPLE SC230BKL

Size = **230** | Colour = **Black** | L = **Laser**

Available Colour	Colour
BK	Black
RD	Red

Part No.	SC230	SC300
Size mm	230	300
Pack Qty	10	10

Computer Eights

- ◆ Available in black, blue and red
- ◆ Also available in other insignia colours on request

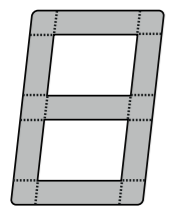

All numbers can be cut from the number '8'



ORDER EXAMPLE SC250RD

Size = **250** | Colour = **Red**

Available Colour	Colour
BU	Blue
BK	Black
RD	Red

Part No.	SC230	SC250	SC300	SC380	SC450
Size mm	236	250	305	380	457
Pack Qty	10	10	10	10	10

Plain Style Sail Numbers

- ◆ Numbers are cut from self adhesive insignia fabric
- ◆ Compatible with all types of polyester and laminate sailcloth
- ◆ Available in black, blue and red
- ◆ Also available in other insignia colours on request



ORDER EXAMPLE SN300BU2

Size = **300** | Colour = **Blue** | No = **2**

Available Colour	Colour
BU	Blue
BK	Black
RD	Red

Part No.	SN100	SN150	SN230	SN250	SN300	SN380	SN450
Size mm	101	150	236	250	307	380	457
Pack Qty	10	10	10	10	10	10	10

Stylised Numbers

- ◆ Available in black, blue, red and white
- ◆ Also available in other insignia colours on request



ORDER EXAMPLE SN001BK5

Colour = **Black** | Number = **5**

Available Colour	Colour
BK	Black
BU	Blue
RD	Red
WT	White

Part No.	Size mm	Pack Qty
SN001	102	10

Plain Style Sail Letters

- ◆ Letters are cut from self adhesive insignia fabric
- ◆ Compatible with all types of polyester and laminate sailcloth
- ◆ Available in black, blue and red
- ◆ Also available in other insignia colours on request



ORDER EXAMPLE

SL300RDB

Size = **300** | Colour = **Red** | Letter = **B**

Available Colour	Colour
BU	Blue
BK	Black
RD	Red

Part No.	SL230	SL250	SL300	SL380	SL450
Size mm	236	250	305	380	457
Pack Qty	10	10	10	10	10

Stylised Letters

- ◆ Available in black, blue, red and white
- ◆ Also available in other insignia colours on request



ORDER EXAMPLE

SL001RDG

Colour = **Red** | Number = **G**

Available Colour	Colour
BK	Black
BU	Blue
RD	Red
WT	White

Part No.	Size mm	Pack Qty
SL001	102	10

Oxford Nylon Bag Cloth

- ◆ Coated Oxford 6oz nylon fabric for the manufacture of bags and dust covers
- ◆ Can be used for a wide variety of other marine and industrial applications

- ◆ Features - Durable coating, weather resistant, tight weave and urethane coated
- ◆ Uses - Back packs, banners, flags, sail bags and soft sided luggage
- ◆ 420 Denier, PU coated

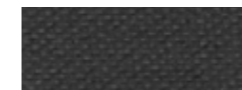

V006BK
Black



V006BR
Bright Red



V006BU
Blue

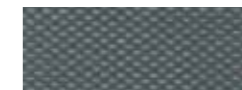

V006DG
Dark Grey



V006GR
Green



V006GY
Grey



V006NB
Navy Blue



V006RD
Red



V006WT
White



V006YE
Yellow

Part No.	Colour	Roll Length m	Roll Width cm	UOM
V006BK	Black	100	150	metre
V006BR	Bright Red	100	150	metre
V006BU	Blue	100	150	metre
V006DG	Dark Grey	100	150	metre
V006GR	Green	100	150	metre
V006GY	Grey	100	150	metre
V006NB	Navy Blue	100	150	metre
V006RD	Red	100	150	metre
V006WT	White	100	150	metre
V006YE	Yellow	100	150	metre

Please note: Colour representations shown are the closest approximate match permissible by print process. Customers should be aware that the colour of products will alter in appearance to the eye by the light and environment, e.g. bright blue environments will change yellow to greener shades.

Extruded Vinyl Rope

- ◆ Manufactured to metric sizes for European designed systems
- ◆ Maintains dimensional stability
- ◆ Use for economy headsail luff tape



Part No.	Diameter mm	Reel Length m	UOM
E491R	4	200	Metre
E492R	5	100	Metre
E493R	6	100	Metre
E494R	7	100	Metre
E495R	8	200	Metre

Polynite Boltropes

- ◆ Low stretch, low shrink polypropylene construction
- ◆ Hard construction for excellent shape retention
- ◆ Available only on full reels



Part No.	Diameter mm	Reel Length m	UOM
E392	6	200	Metre
E393	7	200	Metre
E394	8	200	Metre



Braided Polypropylene Bolt Rope

- ◆ Lightweight and low stretch
- ◆ Special construction to ensure excellent bolt rope qualities

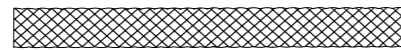

Part No.	Dia: mm	Min break strength: kg	Reel length: m	UOM
KRB007W1	7	700	100	Metre
KRB008W1	8	900	100	Metre
KRB010W1	10	1300	100	Metre
KRB007W2	7	700	200	Metre
KRB008W2	8	900	200	Metre
KRB010W2	10	1300	200	Metre

3 Strand Pre-Shrunk Polyester

- ◆ Ideal for use as bolt rope
- ◆ Pre-shrunk using special processes
- ◆ Remains same length when wet

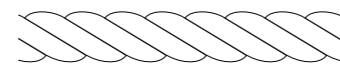

Part No.	Dia: mm	Min break strength: kg	Reel length: m	UOM
KR3S06W2	6	400	200	Metre
KR3S07W2	7	620	200	Metre
KR3S08W2	8	790	200	Metre
KR3S10W2	10	1020	200	Metre



Hard Braid Luffline

- ◆ Material: polyester
- ◆ Construction: braid on braid
- ◆ Hard section lufflines designed for maintaining their cross sectional shape in luff tapes to facilitate smooth hoisting and lowering of the sail
- ◆ Use for headsail luff tape and mainsail bolt rope
- ◆ Available only in white on full reels



Part No.	Dia: mm	Min break strength: kg	Reel length: m	UOM
KRGLU30W5	3	190	500	Metre
KRGLU35W5	3.5	240	500	Metre
KRGLU40W5	4	320	500	Metre
KRGLU45W5	4.5	460	500	Metre
KRGLU50W5	5	600	500	Metre
KRGLU55W5	5.5	700	500	Metre
KRGLU60W3	6	810	300	Metre

Polyester Luffline

- ◆ 100% Polyester
- ◆ Low stretch, stiff rope
- ◆ Good abrasion resistance



Part No.	Dia: mm	Min break strength: kg	Reel length: m	UOM
KRLU03W2	3	190	200	Metre
KRLU35W2	3.5	240	200	Metre
KRLU04W2	4	320	200	Metre
KRLU45W2	4.5	460	200	Metre
KRLU05W2	5	600	200	Metre
KRLU55W2	5.5	700	200	Metre
KRLU06W2	6	810	200	Metre

Dyneema® Leechline

- ◆ Very low stretch
- ◆ Improved flex life compared to most aramid ropes
- ◆ High-tech polyester outer protects Dyneema® core
- ◆ Only available on full reels



Part No.	Diameter mm	Reel Length m	Breaking Load (DAN)	UOM
E345	1.7	500	100	Metre
E347	3	330	370	Metre

Dyneema® Leechline

- ◆ Extremely low stretch
- ◆ High strength Dyneema® braided core
- ◆ Polyester braided cover with great abrasion resistance



Part No.	Dia: mm	Min break strength: kg	Reel length: m	UOM
KRDE03W1	3	370	100	Metre
KRDE04W1	4	820	100	Metre
KRDE15W2	1.5	130	200	Metre
KRDE02W2	2	200	200	Metre
KRDE03W2	3	370	200	Metre
KRDE04W2	4	820	200	Metre

Coated Dyneema® Leechline

- ◆ GP90 coated Dyneema® fibre
- ◆ 100% Dyneema® fibre construction with polyurethane coating
- ◆ Very low stretch and no water absorption
- ◆ Only available on full reels



Part No.	Diameter mm	Reel Length m	Breaking Load (DAN)	UOM
E361	3	100	710	Metre
E362	4	100	1300	Metre
E364	6	100	2700	Metre

Polyester Leechline

- ◆ Braid on braid construction
- ◆ Low stretch
- ◆ Excellent abrasion resistance

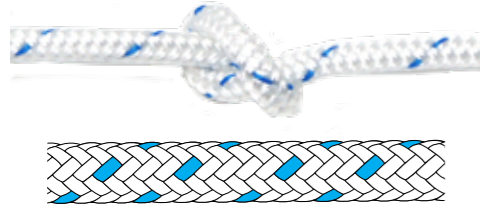

Part No.	Dia: mm	Min break strength: kg	Reel length: m	UOM
KRPL15W2	1.5	80	200	Metre
KRPL02W2	2	115	200	Metre
KRPL25W2	2.5	140	200	Metre
KRPL03W2	3	210	200	Metre
KRPL35W2	3.5	310	200	Metre
KRPL04W2	4	360	200	Metre
KRPL45W2	4.5	485	200	Metre
KRPL05W2	5	610	200	Metre

Braided Leechline

- ◆ Economy line for leechline, drawcord and general applications
- ◆ Only available in full reels



Part No.	Diameter mm	Reel Length m	UOM
E432	2	200	Reel
E434	3	200	Reel
E435	4	100	Reel

Zero AT

- ◆ Anti torsion rope
- ◆ Ideal for furling systems
- ◆ High break load
- ◆ Special construction optimised for transfer of tractional and torsional forces
- ◆ Sold by the metre



Part No.	Dia: mm	Min break strength: kg	UOM
KRAT08X	8	3200	Metre
KRAT10X	10	5500	Metre
KRAT12X	12	8000	Metre
KRAT14X	14	11,000	Metre

Rig 12

- ◆ 12 stand Dyneema®
- ◆ PU coated for improved protection against abrasion
- ◆ Low stretch and easy to splice
- ◆ Ideal for halyards, control lines, lashings and strops



Part No. Black	Part No. Silver	Dia: mm	Min break strength: kg	Reel length: m	UOM
KRRI02B2	KRRI02S2	2	450	100	Metre
KRRI03B1	KRRI03S1	3	900	100	Metre
KRRI04B1	KRRI04S1	4	1400	100	Metre
KRRI05B1	KRRI05S1	5	2400	100	Metre
KRRI06B1	KRRI06S1	6	3200	100	Metre

3 Strand Pre-Stretched Polyester

- ◆ Strong, low stretch and hard wearing
- ◆ Twisted polyester rope
- ◆ Easy to splice

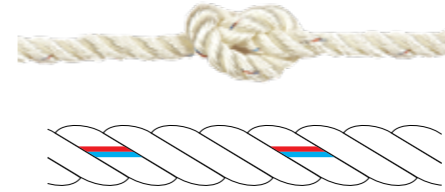

Part No.	Dia: mm	Min break strength: kg	Reel length: m	UOM
KRS307W1	7	1250	100	Metre
KRS308W1	8	1450	100	Metre
KRS310W1	10	2100	100	Metre

8 Plait Standard Polyester

- ◆ Ideal for mouse lines
- ◆ Good general purpose rope



Part No. Black	Part No. White	Dia: mm	Min break strength: kg	Reel length: m	UOM
KRST02X2	KRST02W2	2	115	200	Metre
KRST03X1	KRST03W1	3	185	100	Metre
KRST05X1	KRST05W1	5	540	100	Metre

3 Strand Polyester

- ◆ 100% Polyester
- ◆ Heat set for better balance and lower stretch
- ◆ Soft and strong
- ◆ Very easy to splice

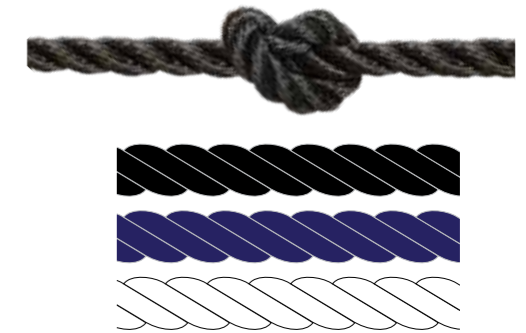

Part No. Black	Part No. Navy Blue	Part No. White	Dia: mm	Min break strength: kg	Reel length: m	UOM
KRP306B1	KRP306N1	KRP306W1	6	650	100	Metre
KRP308B1	KRP308N1	KRP308W1	8	1150	100	Metre
KRP310B1	KRP310N1	KRP310W1	10	1850	100	Metre
KRP312B1	KRP312N1	KRP312W1	12	3000	100	Metre
KRP314B1	KRP314N1	KRP314W1	14	3400	100	Metre
KRP316B1	KRP316N1	-	16	5000	100	Metre

Bainbridge Elastic Shockcord

- ◆ For tensioning, positioning and retrieving
- ◆ Supplied only on full reels



Part No.	Diameter mm	Reel Length m	Colour	UOM
RSESC03WRD	3	250	White/Red	Metre
RSESC04WRD	4	200	White/Red	Metre
RSESC05WRD	5	100	White/Red	Metre
RSESC06WRD	6	100	White/Red	Metre
RSESC08WRD	8	100	White/Red	Metre



Shockcord

- ◆ Braided cover and natural rubber core
- ◆ Made to have 100% stretch and good abrasion resistance

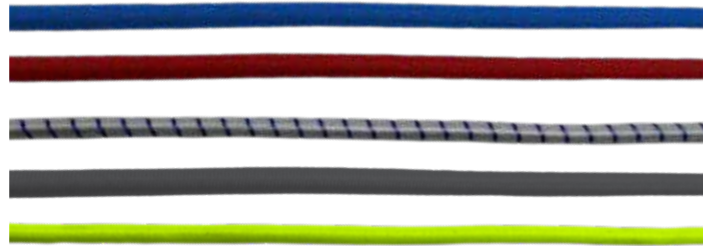

Part No. Blue	Part No. Red	Part No. White	Part No. Black	Part No. Neon Yellow	Dia: mm	Reel length: m	UOM
KRSK03B1	KRSK03R1	KRSK03W1	KRSK03X1	KRSK03Y1	3	100	Metre
KRSK04B1	KRSK04R1	KRSK04W1	KRSK04X1	KRSK04Y1	4	100	Metre
KRSK05B1	KRSK05R1	KRSK05W1	KRSK05X1	KRSK05Y1	5	100	Metre
KRSK06B1	KRSK06R1	KRSK06W1	KRSK06X1	KRSK06Y1	6	100	Metre
-	-	KRSK07W1	KRSK07X1	-	7	100	Metre
-	-	KRSK08W1	KRSK08X1	-	8	100	Metre
-	-	KRSK10W1	KRSK10X1	-	10	100	Metre

Sew on Cover Hooks & Eyelets

- ◆ Injection moulded nylon
- ◆ Sew through plastic with straight stitch sewing machine
- ◆ Can be used alone, or together with lacing and shockcord



Part no	Description	Colour	Pack Qty
A068BK	Eyelet	Black	100
A068WT	Eyelet	White	100
A069BK	Hook	Black	100
A069WT	Hook	White	100

Cover Hooks

- ◆ Manufactured from stainless steel wire
- ◆ Hand sew or use speedy rivets D050N and backplates
- ◆ Suitable for max 10mm shockcord



Part no	Description	Colour	Pack Qty
B401S	Hook	Stainless steel	10
D050N	Speedy Rivet	Nickel plated	100 sets

Eye Strap

- ◆ Used for cord / lacing direction



Part no	Material	Colour	Dim: L x H mm	Pack Qty
G203S	Stainless steel	Silver	37 x 12	10
G204N	Nickel plated brass	Silver	40 x 14	10

Shockcord Fittings

Shockcord Hooks



Part No.	Cord / Wire Size mm	Length mm	Pack Qty
A101	3 - 6	36	100
A102	8 - 10	63	100

Locking Shockcord Hooks



Part No.	Cord / Wire Size mm	Length mm	Pack Qty
A140	6	45	100
A141	8	73	100

Barrel Lock



Part No.	Cord / Wire Size mm	Length mm	Pack Qty
A105	6.3	-	100

Shockcord Clamps



Part No.	Cord / Wire Size mm	Length mm	Pack Qty
B449	3 - 5	-	100
B450	6	-	100
B451	8	-	100
B452	10	-	100
B453	-	-	100

Closing Pliers

- ◆ Closing pliers for all sizes



Part No.	Use with	UOM
C449	B449 - B453	Each

Shockcord Hooks



Part No.	Cord / Wire Size mm	Length mm	Pack Qty
B461	6	-	100
B462	8	-	100

Shockcord Hooks



Part No.	Cord / Wire Size mm	Length mm	Pack Qty
B463	3.2	31	100
B464	4.8	44	100

Shockcord Cover Clips



Part No.	Cord / Wire Size mm	Length mm	Pack Qty
G040BK	-	86	50
G040WT	-	86	50

Shockcord Lock

- ◆ Use on draw strings for bags
- ◆ Two-part simple cam action



Part no	Description	Colour	Pack Qty
A106BK	3mm	Black	10

Cable/Wire Cutters

- ◆ Precision cable cutters by Felco
- ◆ Swiss made
- ◆ Designed to cut wire rope.
- ◆ Max cable 5mm
- ◆ Not suitable for cutting chain



Part No.	Max Cutting Size mm	UOM
C970	5	Each

English Grommets

- ◆ Low cost, roll-rim, spur-toothed grommets suitable for a wide range of applications in sailmaking and cover work
- ◆ Available only in full packs



Part No.	Size	Set Hole Dia mm	Finish	Pack Qty (pcs)
D001NX	000	5.1	Nickel Plated	200
D002NX	00	6.4	Nickel Plated	200
D003NX	0	8.4	Nickel Plated	200
D004NX	1	9.5	Nickel Plated	200
D005NX	2	11.9	Nickel Plated	200
D006NX	3	12.7	Nickel Plated	200
D007NX	4	14.7	Nickel Plated	200
D008NX	5	17.0	Nickel Plated	200
D009NX	6	19.8	Nickel Plated	200

Bulk Packs

Part No.	Size	Set Hole Dia mm	Finish	Pack Qty (pcs)
D001N	000	5.1	Nickel Plated	1000
D002N	00	6.4	Nickel Plated	1000
D003N	0	8.4	Nickel Plated	1000
D004N	1	9.5	Nickel Plated	1000
D005N	2	11.9	Nickel Plated	1000
D006N	3	12.7	Nickel Plated	1000
D007N	4	14.7	Nickel Plated	1000
D008N	5	17.0	Nickel Plated	1000
D009N	6	19.8	Nickel Plated	1000



Bulk Packs

Part No.	Size	Set Hole Dia mm	Finish	Pack Qty (pcs)
D002B	00	6.4	Brass	1000
D003B	0	8.4	Brass	1000
D004B	1	9.5	Brass	1000
D005B	2	11.9	Brass	1000
D006B	3	12.7	Brass	1000
D007B	4	14.7	Brass	1000
D008B	5	17.0	Brass	1000



Part No.	Size	Set Hole Dia mm	Finish	Pack Qty (pcs)
D004SX	1	9.5	Stainless Steel	100
D004S	1	9.5	Stainless Steel	1000

English Grommets – Closing Tools & Hole Punch

- ◆ Tools for English grommets should not be used with Stimpson grommets
- ◆ Do not hit with a steel head hammer or mallet, use a rawhide mallet such as C530 or Maul Master



Cross section when set

Closing Tool Part No.	Hole Punch Part No.	Grommet Part No.	Size	Set Hole Dia mm	Hole Punch Dia mm	UOM
C301	C103	D001B/N	000	5.1	4.8	Each
C302	C105	D002B/N	00	6.4	7.9	Each
C303	C106	D003B/N	0	8.4	9.5	Each
C304	C107	D004B/N	1	9.5	11.1	Each
C305	C108	D005B/N	2	11.9	12.7	Each
C306	C109	D006B/N	3	12.7	14.3	Each
C307	C110	D007B/N	4	14.7	15.9	Each
C308	C111	D008B/N	5	17.0	17.5	Each
C309	C114	D009B/N	6	19.8	22.2	Each

English Grommets - Closing Tool for Stainless Grommets

Closing Tool Part No.	Hole Punch Part No.	Grommet Part No.	Size	Set Hole Dia mm	Hole Punch Dia mm	UOM
C304FS	C107	D004S/FX	1	9.5	11.1	Each

See page 160 for Rawhide Mallet and Maul Master



Stimpson Spur-Toothed Grommets

- ◆ The higher strength of these spur-toothed grommets derives from their thicker metal gauge/flange closing



Part no	Size	Set hole Diameter mm	Material	Pack qty
D003NS	0	6.4	Nickel Plated Brass	144
D004NS	1	7.9	Nickel Plated Brass	144
D005NS	2	10.3	Nickel Plated Brass	144
D006NS	3	11.1	Nickel Plated Brass	144
D007NS	4	14.2	Nickel Plated Brass	144
D008NS	5	15	Nickel Plated Brass	144
D009NS	6	17.4	Nickel Plated Brass	144
D010NS	7	23	Nickel Plated Brass	144
D011NS	8	27.8	Nickel Plated Brass	144
D012NS	10	38.1	Nickel Plated Brass	144

Bulk Packs

Part no	Size	Set hole Diameter mm	Material	Pack qty
D003NSB	0	6.4	Nickel Plated Brass	1440
D004NSB	1	9.5	Nickel Plated Brass	1440
D005NSB	2	10.3	Nickel Plated Brass	1440
D006NSB	3	11.1	Nickel Plated Brass	1440
D007NSB	4	14.2	Nickel Plated Brass	1440
D008NSB	5	15	Nickel Plated Brass	1440



Part No.	Size	Set Hole Dia mm	Material	Qty
D003BS	0	6.4	Solid Brass	144
D004BS	1	9.5	Solid Brass	144
D005BS	2	10.3	Solid Brass	144
D006BS	3	11.1	Solid Brass	144
D007BS	4	14.2	Solid Brass	144
D008BS	5	15	Solid Brass	144
D009BS	6	17.4	Solid Brass	144
D010BS	7	23	Solid Brass	144
D011BS	8	27.8	Solid Brass	144
D012BS	10	38.1	Solid Brass	144



Part No.	Size	Set Hole Dia mm	Material	Qty
D003BKS	0	6.4	Brass/Matte Black	144
D004BKS	1	7.9	Brass/Matte Black	144
D005BKS	2	10.3	Brass/Matte Black	144
D006BKS	3	11.1	Brass/Matte Black	144
D007BKS	4	14.2	Brass/Matte Black	144
D008BKS	5	15	Brass/Matte Black	144
D009BKS	6	17.4	Brass/Matte Black	144
D010BKS	7	23	Brass/Matte Black	144
D011BKS	8	27.8	Brass/Matte Black	144
D012BKS	10	38.1	Brass/Matte Black	144

See page following page for Stimpson Modular Closing Tools



Stimpson Modular Closing Tools

- ◆ Portable grommet hand drive setting tool features a modular design
- ◆ Enables user to change top and bottom setting tools
- ◆ Allows other size grommets and washers to be set using the same bolster and handle
- ◆ Modular hand drive is available as a set or individual components
- ◆ Tool set includes: handle, top and bottom insert tools, bolster insert and hex key for swapping top insert tool

Tool Set

Part No.	For Stimpson Grommet	UOM
C303MS	0	Each
C304MS	1	Each
C305MS	2	Each
C306MS	3	Each
C307MS	4	Each
C308MS	5	Each
C309MS	6	Each
C310MS	7	Each
C311MS	8	Each
C312MS	10	Each

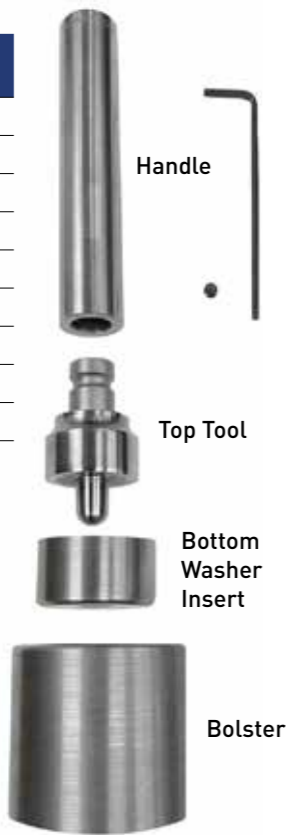

Handle

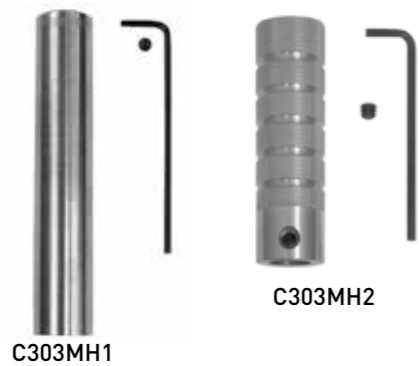

Part No.	For Stimpson Grommet	UOM
C303MH1	0 - 5	Each
C303MH2	6-10	Each

Top Tool

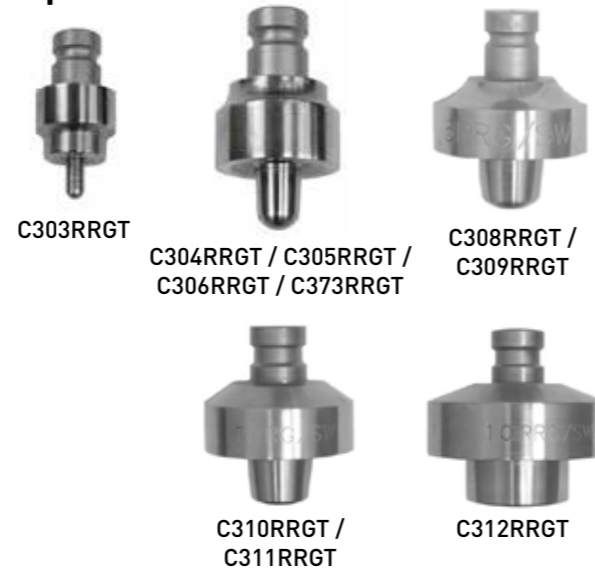

Part No.	For Stimpson Grommet	UOM
C303RRGT	0	Each
C304RRGT	1	Each
C305RRGT	2	Each
C306RRGT	3	Each
C307RRGT	4	Each
C308RRGT	5	Each
C309RRGT	6	Each
C310RRGT	7	Each
C311RRGT	8	Each
C312RRGT	10	Each

Bottom Washer Insert



Part No.	For Stimpson Grommet	UOM
C303SWI	0	Each
C304SWI	1	Each
C305SWI	2	Each
C306SWI	3	Each
C307SWI	4	Each
C308SWI	5	Each
C309SWI	6	Each
C310SWI	7	Each
C311SWI	8	Each
C312SWI	10	Each

Bolster



Part No.	For Stimpson Grommet	UOM
C303MB2	0 - 5	Each
C303MB3	6-10	Each

Tool Punch

- ◆ Fits with handles C303MH1 & CM303MH2 and is interchangeable with top tool



Part No.	Punch Size	For Stimpson Grommet	UOM
C303P	6.4	0	Each
C304P	7.9	1	Each
C305P	10.3	2	Each
C306P	11.1	3	Each
C307P	14.2	4	Each
C308P	15	5	Each
C309P	17.4	6	Each
C310P	23	7	Each
C311P	27.8	8	Each
C312P	38.1	10	Each

Stimpson Grommets - Closing Tools & Hole Punch

- ◆ Not be used with English grommet tools
- ◆ For best results use the correct Stimpson modular die set
- ◆ Low-cost tools are drop forged steel dies
- ◆ Do not hit with a steel head hammer or mallet, use a rawhide mallet such as C530 or Maul Master see page 160



Closing Tool - Stimpson Part No.	Closing Tool - Eco Part No.	Hole Punch Part No.	Size	Set Hole Dia mm	Hole Punch Dia mm
C303MS	C303C	C106	0	6.4	9.5
C304MS	C304C	C107	1	7.9	11.1
C305MS	C305C	C108	2	9.4	12.7
C306MS	C306C	C109	3	11.1	14.3
C307MS	C307C	C110	4	12.7	15.9
C308MS	-	C111	5	15.8	17.5
C309MS	-	C114	6	19.1	22.2

See page 160 for Rawhide Mallet and Maul Master

Polypropylene Webbing

- ◆ New improved polypropylene webbing available in various widths and colours
- ◆ System 3 binder thread webbing process - resists fraying
- ◆ Heat treated for better colour fastness and improved UV properties
- ◆ Suitable for low load application.
- ◆ Sold in full reels only - 50m
- ◆ Other colours available on request



Polypropylene Webbing - 20mm

Part no	Width mm	Colour	Breaking Load kg	Reel size m
EP225BK	20	Black	225	50
EP225BU	20	Blue	225	50
EP225GY	20	Grey	225	50
EP225NB	20	Navy Blue	225	50
EP225WT	20	White	225	50
EP225YE	20	Yellow	225	50

Polypropylene Webbing - 40mm

Part no	Width mm	Colour	Breaking Load kg	Reel size m
EP227BK	40	Black	425	50
EP227BU	40	Blue	425	50
EP227GY	40	Grey	425	50
EP227NB	40	Navy Blue	425	50
EP227RD	40	Red	425	50
EP227WT	40	White	425	50

Polypropylene Webbing - 25mm

Part no	Width mm	Colour	Breaking Load kg	Reel size m
EP226BK	25	Black	275	50
EP226BU	25	Blue	275	50
EP226GR	25	Green	275	50
EP226GY	25	Grey	275	50
EP226NB	25	Navy Blue	275	50
EP226RD	25	Red	275	50
EP226WT	25	White	275	50
EP226YE	25	Yellow	275	50

Polypropylene Webbing - 50mm

Part no	Width mm	Colour	Breaking Load kg	Reel size m
EP228BK	50	Black	525	50
EP228BU	50	Blue	525	50
EP228GR	50	Green	525	50
EP228NB	50	Navy Blue	525	50
EP228RD	50	Red	525	50
EP228WT	50	White	525	50
EP228YE	50	Yellow	525	50

Polyester Webbing

- ◆ Polyester webbing available in various weights and widths
- ◆ Suitable for medium/high load application
- ◆ Sold in full reels only
- ◆ Other colours available on special request



Part no	Width mm	Breaking Load kg	Style	Reel size m
E110	12	300	Standard	50
E111	19	500	Standard	50
E112	25	600	Standard	50
E109	12	400	Heavy	25
E127	20	500	Heavy	25
E113	25	750	Heavy	25
E114	30	850	Heavy	25
E115	40	1000	Heavy	25
E116	50	1200	Heavy	25
E108	63	1400	Heavy	25
E118	25	1500	Extra Heavy	25
E119	30	1800	Extra Heavy	25
E120	40	2400	Extra Heavy	25
E121	51	3100	Extra Heavy	25
E129	45	2800	Super Heavy	25

Polyester Webbing - Tubular

- ◆ New hard/stiffer finish to our popular E124 webbing
- ◆ Lies straight and flat to the sail for easier application
- ◆ Simple to align webbing through multiple layers of sailcloth
- ◆ Suitable for all medium/high load application
- ◆ Ideal webbing for attaching external rings on sails
- ◆ Polyester tubular construction allows for insertion of rope, shockcord or high modulus fibres to increase strength and resist UV
- ◆ Also use in furling sails for head and tack loops
- ◆ Sold in full reels only
- ◆ Bainbridge UK manufacture



Part No.	Width mm	Breaking Load kg	Finish	Reel Size m
E124	25	1700	Standard	50
E124H	25	1700	Hard	50

Nylon Webbing

- ◆ Nylon webbing available in various widths and colours
- ◆ Suitable for medium/high load application
- ◆ Sold in full reels only



Tubular

Part no	Width	Colour	Breaking Load kg	Reel size m
E122	12	White	700	200
E123	19	White	1450	200
E112NBK	25	Black	680	91.44
E124NBK	20	Black	1800	91.44
E124NBU	20	Blue	1800	91.44

Non-tubular

Part no	Width	Colour	Breaking Load kg	Reel size m
E110N	12	White	317	45.72
E110NBK	12	Black	317	91.44
E125	25	Black	460	50

Please note: Colour representations shown are the closest approximate match permissible by print process. Customers should be aware that the colour of products will alter in appearance to the eye by the light and environment, e.g. bright blue environments will change yellow to greener shades.

Kevlar® Reinforced Webbing

- ◆ Polyester cover protects Kevlar® from UV degradation and reduces flexing and chafe
- ◆ Available only on full reels



Part No.	Width mm	Breaking Load kg	Colour	Reel Size m
E131	25	1900	White	25
E133	35	2600	White	25

Kevlar®/Polyester Webbing

- ◆ Warp: Kevlar®, Weft: Polyester
- ◆ Low elongation to high load ratio
- ◆ Suitable for all styles of aramid sails
- ◆ Sold in full reels only

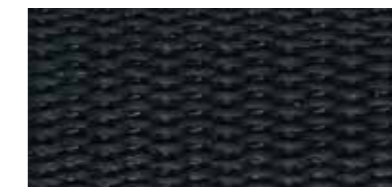

Part No.	Width mm	Breaking Load kg	Colour	Reel Size m
E132	20	1500	Black	25
E134	25	2100	Black	25

Dyneema® Webbing

- ◆ Bainbridge Dyneema® webbing
- ◆ Lighter than Kevlar® and does not absorb water
- ◆ Excellent UV resistance and flex characteristics
- ◆ Dyneema® is a very strong and low stretch fibre
- ◆ Available only on full 25m reels



Part No.	Width mm	Breaking Load kg	Colour	Reel Size m
E135SP	25	2800	Natural	25
E135SPBK	25	2800	Black	25
E139SP	45	4000	Natural	25
E139SPBK	45	4000	Black	25

Please note: Colour representations shown are the closest approximate match permissible by print process. Customers should be aware that the colour of products will alter in appearance to the eye by the light and environment, e.g. bright blue environments will change yellow to greener shades.

Jackstay

- ◆ Rugged polyester webbing
- ◆ Five panel construction
- ◆ Recommended for hiking straps, bag handles, nose piece for kites, reinforcement, tie down, trampolines, etc
- ◆ Excellent UV resistance



E150

Part No.	Width mm	Breaking Load kg	Colour	Reel Size m
E150	25	3000	White	50

Toe Strap & Seatbelt Webbing

- ◆ Rugged polyester webbing
- ◆ Five panel construction
- ◆ Recommended for hiking straps, bag handles, nose piece for kites, reinforcement, tie down, trampolines, etc
- ◆ Excellent UV resistance



Part No.	Colour	Dia: mm	Min break strength: kg	Reel length: m	UOM
E115BK	Black	38	1134	137.1	Metre
E121BK	Black	50	1134	91.4	Metre
KRTSWB50	Blue	50	3200	50	Metre
KRTSWR50	Red	50	3200	50	Metre
KRTSWX50	Black	50	3200	50	Metre

AQUA MARINE

AquaMarine Sail-Ties

- ◆ 25mm polypropylene webbing sail tie
- ◆ 2.0 metre long with stitched loop
- ◆ Unique twisted loop design for ease of use
- ◆ Genuine Bainbridge webbing manufactured in the UK



Part No:	Description	Pack Qty
AQM025BK2	Black	4
AQM025BU2	Blue	4
AQM025GY2	Grey	4
AQM025NB2	Navy blue	4
AQM025RD2	Red	4
AQM025WT2	White	4

Jackstay Life Lines

- ◆ Provide safety without hindering freedom of movement
- ◆ Featuring two loops to attach it to boat

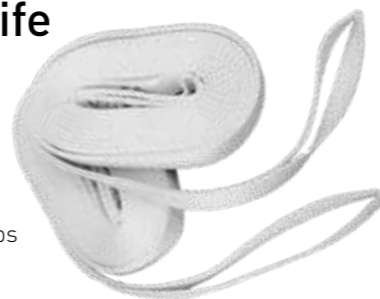

Part No:	Colour/Material	Length: m	Width: mm	UOM
AQM010106	White polyester	6	25	Pair
AQM010107	White polyester	7	25	Pair
AQM010108	White polyester	8	25	Pair
AQM010109	White polyester	9	25	Pair
AQM010110	White polyester	10	25	Pair



Webbing Fittings

- ◆ A selection of buckles and fittings suitable for use with webbing and cover making applications

Cam Buckles



Part no	For webbing mm	Colour	Material	Pack qty
A0701WT	20	White	Nylon	10
A079BK	25	Black	Nylon	10
A0702WT	25	White	Nylon	10
B087	25	Silver	Stainless Steel	10

Ladderlock Buckles



Part no	For webbing mm	Colour	Material	Pack qty
A074	15	Black	Nylon	10
A075	19	Black	Nylon	10
A076	25	Black	Nylon	10
A076HD	25	Black	Heavy Duty Nylon	10
A073	40	Black	Nylon	10

Central Release Buckles



Part no	For webbing mm	Colour	Material	Pack qty
A084	10	Black	Acetal	100
A159BK	19	Black	Acetal	100

Snap Buckles



A085 - A089

Part no	For webbing mm	Colour	Material	Pack qty
A087	15	Black	Nylon	10
A088	19	Black	Nylon	10
A089	25	Black	Nylon	10
A089WT	25	White	Nylon	10
A086	38	Black	Nylon	10
A085	50	Black	Nylon	10

Adjuster Buckles



Part no	For webbing mm	Colour	Material	Pack qty
G210S	25	Flat Bridge	Stainless Steel	10
G211S	25	Raised Bridge	Stainless Steel	10
A122BK	25	Black	Plastic	50
A142BK	38	Black	Plastic	50
A125BK	50	Black	Plastic	50

Sliding Bar Buckles



Part no	For webbing mm	Colour	Material	Pack qty
G221	25	Mixed	Stainless Steel/Nylon	10
G223	40	Mixed	Stainless Steel/Nylon	10
G221S	25	Silver	Stainless Steel	10
G222S	50	Silver	Stainless Steel	10

Please note: Colour representations shown are the closest approximate match permissible by print process. Customers should be aware that the colour of products will alter in appearance to the eye by the light and environment, e.g. bright blue environments will change yellow to greener shades.

Swivel Webbing Buckle with Socket

◆ Bullet: Stainless steel, quick release removable buckle with flush floor mounting



Part No.	Finish	Webbing Width: mm	UOM
G742S	Stainless Steel	25	Each

Webbing Bridges



Part no	For webbing mm	Colour	Material	Pack qty
A095BK	15	Black	Nylon	10
A095WT	19	Black	Nylon	10
A096BK	25	Black	Nylon	10
A096WT	25	White	Nylon	10
A097BK	38	Black	Nylon	10
A097WT	50	Black	Nylon	10
G205S	25	Silver	Stainless Steel	10
G209S	25	Silver	Stainless Steel	10

Tri-Ring for Webbing

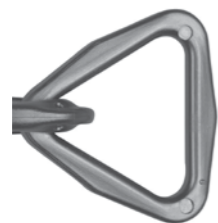

Part no	For webbing mm	Colour	Material	Pack qty
A134BK	25	Black	Plastic	50

Boat Snap Hooks



Part no	For webbing mm	Colour	Material	Pack qty
G200S	25	Silver	Stainless Steel	10

Swivel Snap Eye Bolt for Webbing



Part No:	Length mm	Gap mm	Eye mm	Material	UOM
B637	75	8	25	Bronze	Each

Fast Rigid Snap Hook for Webbing



Part No:	Length mm	Gap mm	Eye mm	Material	UOM
B617S	50	25	Up to 25.4	AISI 304 Stainless Steel	Each



Use this catalogue with our dedicated fabric supplements



These comprehensive catalogues married with real time stock and ordering at bainbridgeint.com allows you the greatest freedom and flexibility to view our product range



Email: info@bainbridgeint.co.uk www.bainbridgeint.co.uk

Utility Tape

- ◆ Individually wrapped to help prolong shelf life
- ◆ Acrylic adhesive
- ◆ Bainbridge original
- ◆ Good initial tack
- ◆ High long term adhesion
- ◆ Low shrink



Part No.	Width mm	Roll Length m	Carrier	To be used with	UOM
J421	6	50	Tissue	All cloth	Roll
J422	9	50	Tissue	All cloth	Roll
J424	15	50	Tissue	All cloth	Roll
J427	30	50	Tissue	All cloth	Roll
J428	40	50	Tissue	All cloth	Roll

Economy Tapes

- ◆ Economy grade seaming tape offering excellent value for money
- ◆ Fair initial tack
- ◆ High long term adhesion
- ◆ Non-yellowing



Part No.	Width mm	Roll Length m	Carrier	To be used with	UOM
J411	6	50	Tissue	All cloth	Roll
J412	9	50	Tissue	All cloth	Roll
J413	12	50	Tissue	All cloth	Roll
J414	15	50	Tissue	All cloth	Roll
J415	19	50	Tissue	All cloth	Roll
J416	25	50	Tissue	All cloth	Roll
J417	30	50	Tissue	All cloth	Roll
J418	40	50	Tissue	All cloth	Roll

Bainbridge Premium Tape

- ◆ High quality strong adhesive tape
- ◆ Optically clear polyester carrier 23µm
- ◆ Acrylic adhesive
- ◆ Ideal for cover making and suitable for use with Solacryl® and SolaTX®
- ◆ Exclusive Bainbridge original - UK manufacture
- ◆ Extremely high long term adhesion
- ◆ Individually wrapped helps prolong shelf life
- ◆ Works from -40° to +120°



Part No.	Width mm	Roll Length m	Carrier	To be used with	UOM
J431	6	50	Polyester	All cloth	Roll
J432	9	50	Polyester	All cloth	Roll
J433	12	50	Polyester	All cloth	Roll
J434	15	50	Polyester	All cloth	Roll
J435	19	50	Polyester	All cloth	Roll
J436	25	50	Polyester	All cloth	Roll
J437	30	50	Polyester	All cloth	Roll

High Adhesion Seaming Tape

- ◆ Outstanding adhesion to all types of sailcloth making this tape ideal for seaming applications
- ◆ Good initial tack
- ◆ High long term adhesion
- ◆ Non-yellowing



Part No.	Width mm	Roll Length m	Carrier	To be used with	UOM
J310	6	50	Tissue	All cloth	Roll
J311	9	50	Tissue	All cloth	Roll
J312	12	50	Tissue	All cloth	Roll
J313	15	50	Tissue	All cloth	Roll
J314	19	50	Tissue	All cloth	Roll
J315	25	50	Tissue	All cloth	Roll

3M Acrylic Transfer Tape

- ◆ High performance transfer tape, more elastic than conventional double sided tapes
- ◆ Transfer tapes do not have a film or cloth carrier
- ◆ Non-yellowing
- ◆ Uses: Excellent for spinnakers and light sails where some stretch in the seam is desired



Part No.	Width mm	Roll Length m	Carrier	To be used with	UOM
J132	9	55	Acrylic Based	Spinnaker Nylon	Roll
J134	19	55	Acrylic Based	Spinnaker Nylon	Roll

3M Seam Bonding Tape

- ◆ Better for the sailcloth, particularly on film/film laminates and nylons where stitching can tear through the cloth
- ◆ Seams often stretch less than conventional sewn seams
- ◆ Can reduce costs as the number of rows of stitching on horizontal seams of large sails can be reduced
- ◆ Seams bonded with Super Seam tape are light and smooth



Part No.	Width mm	Roll Length m	Carrier	To be used with	UOM
J180	12	55	Tissue	Laminate/Nylon	Roll
J181	19	55	Tissue	Laminate/Nylon	Roll
J182	25	55	Tissue	Laminate/Nylon	Roll

Double Sided Tape - Acrylic

- ◆ High quality double sided tape for general sail seaming
- ◆ Fair initial tack
- ◆ High long term adhesion
- ◆ Non-yellowing



Part No.	Width mm	Roll Length m	Carrier	UOM
J451	6	66	Mylar	Roll
J452	9	66	Mylar	Roll
J453	12	66	Mylar	Roll
J455	19	66	Mylar	Roll
J456	25	65	Mylar	Roll

Super Tack Seaming Tape

- ◆ Rubber based adhesive
- ◆ Ultra high tack soft adhesive



Part No.	Width mm	Roll Length m	Carrier	UOM
J472	9	33	Fabric scrim	Roll

Mylar®/Kevlar® Seaming Tape

- ◆ Designed for film/film laminate sails, cloth carrier strengthens seam and re-inforces stitching
- ◆ Fair initial tack
- ◆ High long term adhesive
- ◆ Non yellowing



Part No.	Width mm	Roll Length m	Carrier	To be used with	UOM
J080	12	45.7	Cloth	Film/laminate	Roll
J082	25	45.7	Cloth	Film/laminate	Roll

Seaming Tools

- ◆ The Wrist-Saver roller's patent pending design allows for proper positioning of your arm, wrist and hand into a neutral, relaxed working position
- ◆ The design allows you to use the power of your whole arm and conserve energy
- ◆ Keeps your wrist in a more comfortable position and your arm moves in a natural motion



EVMR02143



EVMR05200



C523

Part No.	Diameter mm	Weight: kg	UOM
EVMR02143	50.8	0.81	Each
EVMR05200	36.5	0.34	Each
C523	31.0	0.42	Each

YKK® – Zippy Cool

- ◆ Help to extend the life of zipper teeth
- ◆ Specially formulated cleaning and lubricating system
- ◆ Effective cleaning and lubricating of all types of metal, coil and plastic zippers
- ◆ Kit comes with: cleaning fluid to remove harmful dirt, sand and salt deposits and wax lubricating stick
- ◆ Remove harmful dirt, sand and salt deposits – great for marine zippers



Part No.	Cleaner volume ml:	Lubricant volume g:	Style	UOM
M030	59	14	Cleaning Fluid and Wax Lubricant	Each
M031	59	-	Cleaning Fluid	Each
M032	-	14	Wax Lubricant	Each

YKK

Little Parts. Big Difference.

YKK® Zippers

YKK® zippers and sliders offered by Bainbridge International have been engineered especially for the marine industry and other outdoor applications.

- ◆ All materials used have been selected to resist damage from UV & corrosion
- ◆ Various sizes available in Vislon® and Coil style
- ◆ Use Bainbridge premium tape can be found on page 104 to make light work of applying zipper chain to any fabric



Dims: mm	A	B	C	D
No. 5	3.7	12	5.7	30
No. 8	4.9	14	7.4	35
No. 10	5.7	15	8.6	38
No. 15	9.1	27	14	68

YKK® Continuous Vislon®

No. 5 - Zip



Part No.	Length m	Colour	UOM
E580	200	White	Metre

No. 5 - Zipper Stops



Part No.	Material	Colour	Style	Pack Qty
E584SSTS	Stainless Steel	Silver	End Stop	200

No. 5 - Sliders



E581 E583

Part No.	Material	Colour	Style	UOM
E581	Metal	White	Single Slider	Each
E583	Plastic	White	Single Slider	Each

No. 8 - Zip

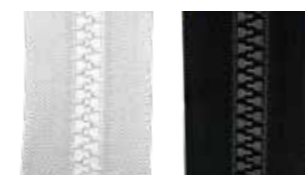

Part No. White	Part No. Black	Length: m	UOM
E601WT	E601BK	100	Metre

No. 8 - Sliders



Part No. White	Part no Black	Material	Style	UOM
E602WT	E602BK	Metal	Single	Each
-	E614BK	Metal	Double	Each

No. 10 - Zip



Part No. White	Part No. Navy	Part No. Grey	Part No. Black	Part No. Beige	UOM
E584	E584NB	E584GY	E584BK	E584BE	Metre

YKK® Continuous Vislon®

No. 10 - Sliders



Part No. White	Part No. Navy	Part No. Grey	Part No. Black	Part No. Beige	Material	Style	UOM
E585	E585NB	E585GY	E585BK	E585BE	Metal	Single	Each
-	-	-	E585BKL	-	Metal	Single Locking	Each
E586	E586NB	E586GY	E586BK	E586BE	Metal	Double	Each
E587	-	-	E587BK	-	Plastic	Single	Each

YKK® Vislon® Jacket

- ◆ Other colours available against special order
- ◆ Use Bainbridge premium tape can be found on page 104 to make light work of applying zipper chain to any fabric



No. 5 - Zip

Part No.	Length: m / ft	Slider Material	Slider	UOM
E598WT	6710 22.0	Metal	Single	Each

No. 8 - Zip



Part No. White	Part No. Black	Length: m / ft	Slider Material	Style	UOM
E605WT	E605BK	1220 4.0	Metal	Single	Each
-	E608BK	1830 6.0	Metal	Single	Each
E609WT	-	8250 27.0	Metal	Single	Each

No. 10 - Zip



Part No. White	Part No. Navy	Part No. Grey	Part No. Black	Part No. Beige	Length: m / ft	Slider Material	Style	UOM
E559WT	E559NB	-	E559BK	E559BE	300 1.0	Metal	Double	Each
E560WT	E560NB	-	E560BK	-	610 2.0	Metal	Double	Each
E571WT	E571NB	-	E571BK	-	762 2.5	Metal	Double	Each
E561WT	E561NB	E561GY	E561BK	E561BE	910 3.0	Metal	Double	Each
E562WT	E562NB	-	E562BK	-	1060 3.5	Metal	Double	Each
E563WT	E563NB	E563GY	E563BK	E563BE	1220 4.0	Metal	Double	Each
E564WT	E564NB	-	E564BK	-	1370 4.5	Metal	Double	Each
E565WT	E565NB	E565GY	E565BK	E565BE	1520 5.0	Metal	Double	Each
E566WT	E566NB	-	E566BK	-	1680 5.5	Metal	Double	Each
E567WT	E567NB	E567GY	E567BK	E567BE	1830 6.0	Metal	Double	Each
E568WT	E568NB	-	E568BK	-	1980 6.5	Metal	Double	Each
E570WT	E570NB	E570GY	E570BK	E570BE	2130 7.0	Metal	Double	Each
E572WT	E572NB	E572GY	E572BK	E572BE	2440 8.0	Metal	Double	Each
E574WT	E574NB	E574GY	E574BK	E574BE	2740 9.0	Metal	Double	Each
E576WT	E576NB	E576GY	E576BK	E576BE	3050 10.0	Metal	Double	Each
E573WT	E573NB	E573GY	E573BK	E573BE	3340 11.0	Metal	Double	Each
E577WT	E577NB	-	E577BK	-	3660 12.0	Metal	Double	Each
E578WT	E578NB	E578GY	E578BK	E578BE	4579 15.0	Metal	Double	Each
E579WT	-	-	-	-	5950 19.5	Metal	Double	Each
E575WT	E575NB	E575GY	E575BK	E575BE	6400 21.0	Metal	Double	Each
E600WT	-	-	-	-	6710 22.0	Metal	Double	Each
E558WT	E558NB	E558GY	E558BK	E558BE	7620 25.0	Metal	Double	Each
E569WT	-	-	-	-	10000 32.8	Metal	Double	Each



YKK® Vislon® Jacket

No. 15 - Zip

- ◆ Use our premium J43* tape [see page 104] to make light work of applying zipper chain to any fabric
- ◆ Super strong, robust open ended zip for heavy duty construction / applications
- ◆ Suitable uses for backpacks/boombags, deck bags, awnings and yurts



Part No. White	Part No. Black	Length: m / ft	Slider Material	Style	UOM
E610WT	E610BK	1520 5.0	Metal	Single	Each
E611WT	E611BK	3500 11.5	Metal	Single	Each
E612WT	E612BK	5000 16.42	Metal	Single	Each
E613WT	E613BK	7500 24.58	Metal	Single	Each

YKK® Continuous Coil

- ◆ Continuous Coil only available in white and black



Dims: mm	A	B	C	D
No. 5	1	13	6.4	33
No. 8	6.4	14	10	38

No. 5 - Sliders



Part No. White	Part No. Black	Material	Style	UOM
E589	E589BK	Metal	Single	Each

No. 10 - Sliders



Part No. White	Part No. Black	Part No. Nickel	Material	Style	UOM
E592	E592BK	-	Metal	Single	Each
E593	E593BK	-	Metal	Double	Each
-	-	E594	Metal	Double	Each

No. 5 - Zip

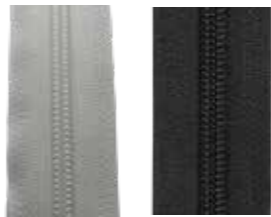

Part No. White	Part No. Black	Length: m	Style	UOM
E588	E588BK	200	Continuous	Metre

No. 10 - Zip



Part No. White	Part No. Black	Length: m	Style	UOM
E591	E591BK	100	Continuous	Metre

YKK® Zipper Stops



Part No. White	Part No. Black	Style	Pack Qty
E584TS	E584TSBK	Top Stop	WT200 / BK100
E584BS	E584BSBK	Bottom Stop	100



'Catchy' Sew-On Hook & Loop Closure

- ◆ Genuine Bainbridge polyester hook and loop original manufactured in the UK
- ◆ Available in a range of sizes: 20, 25, 30, 38, 50 and 100mm
- ◆ White and black stocked in all sizes
- ◆ Navy blue, beige and grey stocked in 25 and 50mm
- ◆ High shear tensile strength
- ◆ Full 25m reels only



Hook



Loop

Selvedge



SEW-ON - Hook & Loop Set

Part No. White	Part No. Navy	Part No. Black	Part No. Grey	Part No. Beige	Width: mm	Reel Size: m
E7020WT	-	E7020BK	-	-	20	25
E7025WT	E7025NB	E7025BK	E7025GY	E7025BE	25	25
E7030WT	-	E7030BK	-	-	30	25
E7038WT	-	E7038BK	-	-	38	25
E7050WT	E7050NB	E7050BK	E7050GY	E7050BE	50	25
E7100WT	-	E7100BK	-	-	100	25

SEW-ON - Hook Only

Part No. White	Part No. Navy	Part No. Black	Part No. Grey	Part No. Beige	Width: mm	Reel Size: m
E7020WTH	-	E7020BKH	-	-	20	25
E7025WTH	E7025NBH	E7025BKH	E7025GYH	E7025BEH	25	25
E7030WTH	-	E7030BKH	-	-	30	25
E7038WTH	-	E7038BKH	-	-	38	25
E7050WTH	E7050NBH	E7050BKH	E7050GYH	E7050BEH	50	25
E7100WTH	-	E7100BKH	-	-	100	25

SEW-ON - Loop Only

Part No. White	Part No. Navy	Part No. Black	Part No. Grey	Part No. Beige	Width: mm	Reel Size: m
E7020WTL	-	E7020BKL	-	-	20	25
E7025WTL	E7025NBL	E7025BKL	E7025GYL	E7025BEL	25	25
E7030WTL	-	E7030BKL	-	-	30	25
E7038WTL	-	E7038BKL	-	-	38	25
E7050WTL	E7050NBL	E7050BKL	E7050GYL	E7050BEL	50	25
E7100WTL	-	E7100BKL	-	-	100	25



'Catchy' Self-adhesive Hook & Loop Closure

- ◆ Genuine Bainbridge polyester hook and loop original manufactured in the UK
- ◆ Available in a range of sizes: 20, 25, 30, 38, 50 and 100mm
- ◆ White and black stocked in all sizes
- ◆ Navy blue, beige and grey stocked in 25 and 50mm
- ◆ High shear tensile strength
- ◆ Full 25m reels only



Hook



Loop

Selvedge



SELF-ADHESIVE - Hook & Loop Set

Part No. White	Part No. Navy	Part No. Black	Part No. Grey	Part No. Beige	Width: mm	Reel Size: m
E8020WT	-	E8020BK	-	-	20	25
E8025WT	E8025NB	E8025BK	E8025GY	E8025BE	25	25
E8030WT	-	E8030BK	-	-	30	25
E8038WT	-	E8038BK	-	-	38	25
E8050WT	E8050NB	E8050BK	E8050GY	E8050BE	50	25
E8100WT	-	E8100BK	-	-	100	25

SELF-ADHESIVE - Hook Only

Part No. White	Part No. Navy	Part No. Black	Part No. Grey	Part No. Beige	Width: mm	Reel Size: m
E8020WTH	-	E8020BKH	-	-	20	25
E8025WTH	E8025NBH	E8025BKH	E8025GYH	E8025BEH	25	25
E8030WTH	-	E8030BKH	-	-	30	25
E8038WTH	-	E8038BKH	-	-	38	25
E8050WTH	E8050NBH	E8050BKH	E8050GYH	E8050BEH	50	25
E8100WTH	-	E8100BKH	-	-	100	25

SELF-ADHESIVE - Loop Only

Part No. White	Part No. Navy	Part No. Black	Part No. Grey	Part No. Beige	Width: mm	Reel Size: m
E8020WTL	-	E8020BKL	-	-	20	25
E8025WTL	E8025NBL	E8025BKL	E8025GYL	E8025BEL	25	25
E8030WTL	-	E8030BKL	-	-	30	25
E8038WTL	-	E8038BKL	-	-	38	25
E8050WTL	E8050NBL	E8050BKL	E8050GYL	E8050BEL	50	25
E8100WTL	-	E8100BKL	-	-	100	25

VELCRO® Brand Sew-On

- ◆ VELCRO® brand original sew on fastening available in sets, and separate hook and loop.
- ◆ Available in navy blue, white and black
- ◆ Durable hook fastening gives maximum life cycle
- ◆ Available only on 25m reels
- ◆ Various widths in 20mm, 25mm, 30mm & 50mm
- ◆ VELCRO® original



SEW-ON - Hook & Loop Set

Part no: White	Part no: Navy	Part no: Black	Part no: Royal Blue	Width: mm	Reel Size: m
E500	-	-	-	16	25
E510	E513	E511	E512	20	25
E515	E518	E517	-	25	25
E520	E523	E521	-	30	25
E530	E533	E531	E532	50	25
E534	-	-	-	100	25
E535	-	E537	E536	150	25

SEW-ON - Hook Only

Part no: White	Part no: Navy	Part no: Black	Part no: Royal Blue	Width: mm	Reel Size: m
E500H	-	-	-	16	25
E510H	E513H	E511H	E512H	20	25
E515H	E518H	E517H	-	25	25
E520H	E523H	E521H	-	30	25
E530H	E533H	E531H	E532H	50	25
E534H	-	-	-	100	25
E535H	-	E537H	E536H	150	25

SEW-ON - Loop Only

Part no: White	Part no: Navy	Part no: Black	Part no: Royal Blue	Width: mm	Reel Size: m
E500L	-	-	-	16	25
E510L	E513L	E511L	E512L	20	25
E515L	E518L	E517L	-	25	25
E520L	E523L	E521L	-	30	25
E530L	E533L	E531L	E532L	50	25
E534L	-	-	-	100	25
E535L	-	E537L	E536L	150	25

VELCRO® Brand Adhesive Backed

- ◆ Supplied in full rolls only
- ◆ Easily stored and gives you the flexibility to cut the length you need
- ◆ VELCRO® brand PS-14 - general adhesive
- ◆ Rubber based adhesive, offering great tack
- ◆ Can be used in temperature ranges from -15C to 60C



SELF-ADHESIVE- Hook & Loop Set

Part no: White	Part no: Navy	Part no: Black	Width: mm	Reel Size: m
E540	-	E541	25	25
E543	-	E544	30	25
E545	E547	E546	50	25

SELF-ADHESIVE - Hook Only

Part no: White	Part no: Navy	Part no: Black	Width: mm	Reel Size: m
E540H	-	E541H	25	25
E543H	-	E544H	30	25
E545H	E547H	E546H	50	25

SELF-ADHESIVE - Loop Only

Part no: White	Part no: Navy	Part no: Black	Width: mm	Reel Size: m
E540L	-	E541L	25	25
E543L	-	E544L	30	25
E545L	E547L	E546L	50	25



Dabond® Machine Threads

Heminway & Bartlett Dabond 2000 thread sets industry standards due to its:

- ◆ High strength and controlled stretch.
- ◆ Resistance to abrasion and salt water.
- ◆ Stability in sunlight and resistance to mildew.
- ◆ Bonding and resistance to needle heat.
- ◆ Continuous thread: no knots/breaks in thread.

Thread Selection Chart

Dabond® Part No.	Needle Size		Average Yield		Average Tensile	
	Imperial	Metric	M	Yd per lb	kg	lb
V30	11-14	75-90	12951	14170	2.13	4.7
V46	12-15	80-95	7467	8170	3.36	7.4
V69	15-18	95-110	5110	5590	4.95	10.9
V92	17-20	105-125	3866	4230	6.58	14.5
V138	19-21	120-130	2523	2760	10.26	22.6
V207	21-23	130-160	1682	1840	14.71	32.4
V346	23-26	-	1005	1100	26.38	58.1



Heminway & Bartlett Anti Wick NANO Bonded Thread

- ◆ Nominal 450g / 1lb spools
- ◆ Heminway & Bartlett Dabond® 2000 thread sets industry standards
- ◆ High strength and controlled stretch
- ◆ Resistance to abrasion and salt water
- ◆ Stability in sunlight and resistance to mildew

Part No. White	Part No. Black	Part No. Blue	Part No. Pacific Blue	Dabond® Size	Nearest Metric Size	UOM
EA069WT	-	-	-	V69	NM36	lb
EA092WT	EA092BK	EA092BU	EA092PB	V92	NM25	lb
EA138WT	EA138BK	-	-	V138	NM20	lb

Heminway & Bartlett Dabond® NANO Thread

- ◆ Bonding and resistance to needle heat
- ◆ Continuous thread with no knots or breaks

Part No. White	Part No. Black	Part No. Blue	Part No. Grey	Part No. Tan	Dabond® Size	Nearest Metric Size	UOM
ET030WT	-	-	-	-	V30	NM80	lb
ET046WT	-	ET046BU	-	-	V46	NM60	lb
ET069WT	-	ET069BU	ET069GY	-	V69	NM40	lb
ET069WT1	-	-	-	-	-	-	1oz
ET092WT	ET092BK	ET092BU	ET092GY	-	V92	NM30	lb
ET138WT	ET138BK	ET138BU	ET138GY	ET138TN	V138	NM20	lb
ET207WT	ET207BK	-	-	-	V207	NM13	lb
ET346WT	-	-	-	-	V346	NM80	lb

Heminway & Bartlett Dabond® Pre-Wound Bobbins

- ◆ These bobbins are wound on a thin core and therefore can have up to 30% more thread per bobbin than can be wound on by a sewing machine
- ◆ Saves time and effort with fewer bobbin changes and longer continuous seams
- ◆ Hembobs are supplied only in full packs of 144 bobbins



Part No.	Dabond® Size	Colour	Pack Qty
EB046FWT	V46 Type F	White	144
EB046GWT	V46 Type G	White	144
EB046LWT	V46 Type L	White	144
EB069DWT	V69 Type D	White	144
EB069GWT	V69 Type G	White	144
EB069LTN	V69 Type L	Tan	144
EB069LWT	V69 Type L	White	144
EB092DWT	V92 Type D	White	144
EB092FWT	V92 Type F	White	144
EB092GWT	V92 Type G	White	144
EB092LWT	V92 Type L	White	144

Coats® Dabond® Outdoor UVR Thread

- ◆ Excellent resistance for applications exposed to marine water and sunlight
- ◆ Dual level lubricated finish for needle heat protection and smooth sewing
- ◆ Excellent bleach, mildew and rot resistance
- ◆ Enhanced resistance to cleaning chemicals
- ◆ Colourfast against vinyl, UV and chemicals
- ◆ Main applications: Sailmaking, awnings, boat tops, marine seating, bimini tops, pool covers, tents and outdoor architectural structures
- ◆ NM20 / V138 and NM25 / V92 - Spool length: 2000m
- ◆ NM40 / V69 - Spool length: 3000m



Part no:		Threadsize: NM20/V138 Length: 2000m	Colour	UOM
Threadsize: NM40/V69 Length: 3000m	Threadsize: NM25/V92 Length: 2000m			
ED040BK	ED025BK	ED020BK	Jet Black	Spool
ED040CGY	ED025CGY	ED020CGY	Charcoal Grey	Spool
ED040NV	ED025NV	ED020NV	Navy	Spool
ED040PBU	ED025PBU	ED020PBU	Pacific Blue	Spool
ED040WT	ED025WT	ED020WT	Natural White	Spool
ED040BE	ED025BE	-	Beige	Spool
ED040BG	ED025BG	-	Burgundy	Spool
ED040CNV	ED025CNV	-	Captain Navy	Spool
ED040GR	ED025GR	-	Forest Green	Spool
ED040GY	ED025GY	-	Cadet Grey	Spool
ED040HBE	ED025HBE	-	Heather Beige	Spool
ED040LN	ED025LN	-	Linen	Spool
ED040MBU	ED025MBU	-	Mediterranean Blue	Spool
ED040OY	ED025OY	-	Oyster	Spool
ED040RD	ED025RD	-	Jockey Red	Spool
ED040SP	ED025SP	-	Spruce	Spool
ED040TC	ED025TC	-	Terracotta	Spool
ED040TP	ED025TP	-	Taupe	Spool
ED040TST	ED025TST	-	Toast	Spool

Please note: Colour representations shown are the closest approximate match permissible by print process. Customers should be aware that the colour of products will alter in appearance to the eye by the light and environment, e.g. bright blue environments will change yellow to greener shades.

SunStop Anti-Wick Thread

- ◆ A high performance twisted multifilament polyester sewing thread
- ◆ Specially designed for outdoor applications where seam strength retention and fade prevention during UV exposure are required
- ◆ Anti-wicking
- ◆ 8oz spools (1/2 lb)
- ◆ Excellent UV resistance
- ◆ Fade resistant
- ◆ Top 16 most popular acrylic colours to closely match Solacryl and Sunbrella acrylics



Part No. White Threadsize: V92 / NM30	Part No. Black Threadsize: V138 / NM20	Colour	Weight	UOM
EY092WT8	EY138WT8	White	8oz / 1/2lb	Each
EY092CNV8	EY138CNV8	Captain Navy	8oz / 1/2lb	Each
EY092NV8	EY138PB8	Navy Blue	8oz / 1/2lb	Each
EY092PB8	EY138RD8	Pacific Blue	8oz / 1/2lb	Each
EY092BK8	EY138BK8	Black	8oz / 1/2lb	Each
EY092GY8	EY138GY8	Cadet Grey	8oz / 1/2lb	Each
EY092SR8	EY138SR8	Silver	8oz / 1/2lb	Each
EY092BRN8	EY138BR8	Brown	8oz / 1/2lb	Each
EY092BEG8	EY138BEG8	Beige	8oz / 1/2lb	Each
EY092TS8	EY138TS8	Toast	8oz / 1/2lb	Each
EY092LN8	EY138LRD8	Linen	8oz / 1/2lb	Each
EY092BG8	EY138BG8	Burgundy	8oz / 1/2lb	Each
EY092JRD8	EY138LN8	Jockey Red	8oz / 1/2lb	Each
EY092LRD8	EY138NV8	Logo Red	8oz / 1/2lb	Each
EY092FGR8	EY138FGR8	Forset Green	8oz / 1/2lb	Each

SolarFix® PTFE Thread

- ◆ SolarFix® thread is guaranteed to last!
- ◆ Made of 100% PTFE (PolyTetraFlouroEthylene) fibre
- ◆ SolarFix® is the best thread choice for all marine and outdoor applications
- ◆ Extremely resistant to harmful UV rays and atmospheric degradation
- ◆ SolarFix® thread will not lose any significant strength due to UV
- ◆ Limited lifetime warranty



Part No. Clear	Part No. Black	Part No. White	Dabond® Size	Nearest Metric Size	Qty per Cob: m	UOM
EF1500CH1T	EF1500DH1T	EF1500WH1T	V92	1500	3400	Spool
EF2640CH1T	EF2640DH1T	EF2640WH1T	V138	2640	1920	Spool

Serafil Thread - Mini Cobs

- ◆ Outstanding UV resistance due to special dye stuffs
- ◆ High-performance bonded special sewing thread for sails and other outdoor applications
- ◆ Extremely durable



Part No. Beige	Part No. Black	Part No. Navy	Part No. White	Dabond® Size	Nearest Metric Size	Qty per Cob: m	UOM
ESF030BE	ESF030BK	ESF030NV	ESF030WT	V92	NM30	900	Spool
ESF040BE	ESF040BK	ESF040NV	ESF040WT	V69	NM40	1200	Spool

NOTE: Full size cobs in a full range of colours are available on request

Serabond Thread

- ◆ High-performance bonded special sewing thread for sails and other outdoor applications
- ◆ Extremely durable
- ◆ Resistant to untwisting and therefore suited for multidirectional sewing
- ◆ Outstanding UV resistance due to special dye stuffs



Threadsize: NM20 / V138 Length: 1600m	Part No.			Colour	UOM
	Threadsize: NM30 / V92 Length: 2300m	Threadsize: NM40 / V69 Length: 4600m	Threadsize: NM60 / V46 Length: 5000m		
ES020WT	ES030WT	ES040WT	ES060WT	White	Spool
-	ES030NV	-	-	Navy Blue	Spool
-	ES030PBU	-	-	Pacific Blue	Spool
ES020BU	ES030BU	ES040BU	-	Blue	Spool
ES020BK	ES030BK	ES040BK	-	Black	Spool
ES020CG	ES030CGY	ES040CG	-	Charcoal Grey	Spool
-	ES030PGY	ES040PGY	-	Pearl Grey	Spool
-	ES030SS	ES040SS	-	Sandstone	Spool
-	ES030YE	-	-	Yellow	Spool
-	ES030BG	-	-	Burgundy	Spool
-	ES030RD	ES040RD	-	Red	Spool
-	ES030GR	-	-	Green	Spool

Please note: Colour representations shown are the closest approximate match permissible by print process. Customers should be aware that the colour of products will alter in appearance to the eye by the light and environment, e.g. bright blue environments will change yellow to greener shades.

Hand Sewing Thread & Wax

- ◆ Hand sewing thread and sailmaker wax
- ◆ Supplied on spools only
- ◆ White waxed thread ideal for repair kits

Waxed Hand Sewing Thread



Part No.	Description	Spool Weight g	Colour	UOM
EW346	V-346	454	White	LB
EW462	V-462-M	454	White	LB
EW499	V-9-C	454	White	LB

Waxed Sewing Thread



Part No.	Weight g	Colour	UOM
ET353	30	White	Spool

Waxed Lacing Tape



EW351 / EW352

EW352BK

Part No.	Spool Length m	Tape Width mm	Colour	UOM
EW351	457	1.6	White	Spool
EW352	457	3.2	White	Spool
EW352BK	457	3.2	Black	Spool

Waxed Hand Sail Twine Bobbins



Part No.	Description	Bobbin Length m	Colour	UOM
EW500	V-6-M	24	White	Box of 12

Wax



C040



C041

Part No.	Description	Weight g	Colour	UOM
C040	Natural bees wax	85	Yellow	Each
C041	Composite thread wax	454	White	Each

Vinyl Bias Binding Tape

- ◆ Marine grade vinyl double folded bias binding tape
- ◆ Finished to 19mm / 3/4" width
- ◆ Mildew treated for outdoor use, good tear and tensile strength
- ◆ Ideal for binding for cushions, canopies, dodgers and biminis



Part No.	Colour	Roll Length m	Width mm	UOM
E075WT	White	91	19	Reel

Solacryl Acrylic Binding

- ◆ Centrefold acrylic binding available in 22mm / 7/8" widths
- ◆ Woven with acrylic yarns
- ◆ Matching or contrasting binding can be used to trim boat covers, cushions, canopies, dodgers and biminis etc
- ◆ Sold in full reels only



Part No.	Colour	Roll Length m	Width mm	UOM
E099BG	Burgundy	100	22	Reel
E099BI	Beige	100	22	Reel
E099BK	Black	100	22	Reel
E099CCGY	Charcoal Grey	100	22	Reel
E099CNV	Captain Navy	100	22	Reel
E099FGR	Forest Green	100	22	Reel
E099NV	Navy	100	22	Reel
E099WT	White	100	22	Reel

STAMOID® Vinyl Binding

- ◆ Stamoid vinyl has outstanding UV resistance
- ◆ Dirt repellent and washable
- ◆ Waterproof and treated against mildew
- ◆ Matching binding is used with Stamoid to trim or bind cushions, canopies, dodgers and biminis etc
- ◆ Sold in full reels only



Part No.	Colour	Roll Length m	Width mm	UOM
E085BK	Black	91	19	Reel
E085CR	Cream	91	19	Reel
E085IV	Ivory	91	19	Reel
E085NV	Navy	91	19	Reel
E085RB	Royal Blue	91	19	Reel
E085SD	Sand	91	19	Reel
E085SW	Snow White	91	19	Reel
E085WT	White	91	19	Reel
E086BK	Black	91	25	Reel
E086WT	White	91	25	Reel

Please note: Colour representations shown are the closest approximate match permissible by print process. Customers should be aware that the colour of products will alter in appearance to the eye by the light and environment, e.g. bright blue environments will change yellow to greener shades.

Canopy Eye Ends & Plugs

Canopy eye end fittings for use on stainless steel tubing have been designed specifically for the marine cover, auto and awning industries.

- ◆ Produced from either type 316 stainless steel with a mirror polished finish or nylon so that they will not corrode
- ◆ Ideal for sprayhoods, biminis, cockpits and sun deck awnings

Eye Ends

- ◆ G611S & G612S eye ends have a 6.35mm / 1/4" pin hole in the eye tab
- ◆ G631SHD & G641SHD have 2 set screws and 7.9mm / 5/16" pin hole in eye tab



G611S / G621S

G631SHD / G641SHD

Part No.	Finish	Fitting Type	Tube Size mm	UOM
G611S	Stainless Steel 316	Tube	19	Each
G612S	Stainless Steel 316	Tube	22	Each
G631SHD	Stainless Steel 316	Tube	25	Each
G641SHD	Stainless Steel 316	Tube	31	Each

Nylon Eye End

- ◆ High strength black nylon fittings
- ◆ Excellent resistance to UV
- ◆ Works with either stainless steel or aluminium tubing



Part No.	Finish	Fitting Type	Tube Size mm / inch	UOM
G621BK	Black / Nylon	Tube	22 / 7/8	Each

Ball Eye Ends



Part No.	Finish	Fitting Type	Tube Size mm	UOM
G671S	Stainless Steel	Tube	19	Each
G681S	Stainless Steel	Tube	25	Each

End Plugs

- ◆ White nylon injection moulding around 3mm stainless steel
- ◆ Plug secured by gluing, with a self tapping screw, or by a dowel pin



G675

G676

G679

Part No.	Finish	Fitting Type	Tube Size mm	UOM
G675	Nylon/Stainless Steel 316	Tube	19	Each
G676	Nylon/Stainless Steel 316	Tube	19	Each
G679	Nylon/Stainless Steel 316	Tube	22	Each

Ball and Socket

- ◆ Ball and socket design offers quick and easy fold and removal of bimini tops
- ◆ Components: G675S, G681S & G678S, see page 125
- ◆ Neater system than traditional arrangements
- ◆ Compact and streamline



Part No.	Finish	Fitting Type	Tube Size mm	UOM
G678S	Stainless Steel 316	Ball & Socket 90° Eye End	22	Each

Canopy Jaw & Hinge Slides

Canopy jaw slide fittings for use on stainless steel tubing have been designed specifically for the marine cover, auto and awning industries.

- ◆ Produced from either type 316 stainless steel with a mirror polished finish or nylon so that they will not corrode
- ◆ Ideal for sprayhoods, biminis, cockpits and sun deck awnings
- ◆ Features a quick release pin

Jaw Slides

- ◆ G630SHD has 2 set screws and 6.35mm / 1/4" pin hole
- ◆ G640SHD has 2 set screws and 7.9mm / 5/16" pin hole



G610S

G620S

G630SHD

G640SHD

G620SS / G623SS

Part No.	Finish	Fitting Type	Tube Size mm	UOM
G610S	Stainless Steel 316	Tube	19	Each
G620S	Stainless Steel 316	Tube	22	Each
G630SHD	Stainless Steel 316	Tube	25	Each
G640SHD	Stainless Steel 316	Tube	32	Each
Grub Screw				
G620SS	Stainless Steel 316	-	-	Pack 10
G623SS	Stainless Steel 316	-	-	Pack 10

Bainbridge Jaw Slide

- ◆ Slides onto tubing
- ◆ Holds in place by 2 x Allen grub screws
- ◆ Excellent resistance to UV
- ◆ Works with either stainless steel or aluminium tubing
- ◆ Supplied with pin with tapped thread in body



Part no	Finish	Fitting Type	Tube Size mm / inch	UOM
G620BK	Black / Nylon	Tube	22 / 7/8	Each

Separating Jaw Slides

- ◆ Mounts without the need to disassemble the rail
- ◆ Ideal for use on rails that are welded together
- ◆ Split jaw slide permanently attached together to enable easier attachment to the rail in the exact position you desire
- ◆ Pack consists of one rail fitting and a stainless steel screw and nut
- ◆ Order G625PIN or G627PIN to connect eye ends with 6.35mm / 1/4" pins, see page 126



G820S

G830S

G840SSP

G840S

Part No.	Finish	Fitting Type	Tube Size mm	UOM
G820S	Stainless Steel 316	Tube	22	Each
G830S	Stainless Steel 316	Tube	25	Each
G840S	Stainless Steel 316	Tube	31	Each
G840SSP	Stainless Steel 316	Tube	31	Each

Double Jaw Slide with Swivel Hinge



Part No.	Finish	Fitting Type	Tube Size mm	UOM
G697S	Stainless Steel 316	Double Tube	25	Each

Socket Jaw Slides



Part No.	Finish	Fitting Type	Tube Size mm	UOM
G672S	Stainless Steel	Tube	22	Each
G682S	Stainless Steel	Tube	25	Each

Canopy Hand Clamp

- ◆ Large nylon tensioning knob allows quick and simple adjustment
- ◆ Clamp comes complete with spacer and screw to use with end plugs
- ◆ Clamp fits over tube and allows movement of the plug space end fitting
- ◆ Tension by hand



Part No.	Finish	Fitting Type	Tube Size mm	UOM
G650WT	Nylon / Stainless Steel 316	Tube	19	Each
G651WT	Nylon / Stainless Steel 316	Tube	19	Each
G652WT	Nylon / Stainless Steel 316	Tube	22	Each
G653WT	Nylon / Stainless Steel 316	Tube	25	Each

Tube Clamp

- ◆ Clamp comes complete with spacer and screw to use with end plugs
- ◆ Clamp fits over tube and allows movement of the plug space end fitting



Part No.	Finish	Fitting Type	Tube Size mm	UOM
G655	Stainless Steel 316	Tube	19	Each

Tubing Hinges

- ◆ Heavy duty design and construction
- ◆ Alloys frame folding
- ◆ Quick release locking pin



Part No.	Finish	Fitting Type	Tube Size mm	UOM
G744S	Stainless Steel 316	Tube	22	Each
G747S	Stainless Steel 316	Tube	25	Each

Gemlock Snap Button

- ◆ Gemlock hinge system is the most simple and effective way to build collapsible supports and folding frames
- ◆ Simple operation: Slide back the locking sleeve and pop the hinge to fold frame
- ◆ All stainless steel designed for tubing 18mm to 32mm inside diameter



Part No.	Finish	Fitting Type	Tube Size mm	UOM
G758	Stainless Steel 316	Tube	18 - 32	Each

Canopy Deck Fittings

Canopy deck mount fittings for use on stainless steel tubing have been designed specifically for the marine cover, auto and awning Industries

- ◆ Produced from either type 316 stainless steel with a mirror polished finish or nylon so that they will not corrode.
- ◆ Ideal for sprayhoods, biminis, cockpits and Sun Deck Awnings

Canopy Slide Tracks

- ◆ G590 is a universal deck fitting mounted on 16mm track for simple and quick stowage
- ◆ G590C is a canopy slide unit only
- ◆ 30cm / 12" length of type 316 stainless steel track supplied with plastic endcaps
- ◆ Use with G675, G676 and G679
- ◆ Easily operated by hand



Part No.	Finish	Fitting Type	Tube Size mm	UOM
G590	Nylon / Stainless Steel 316	Deck	Each	Each
G590C	Nylon / Stainless Steel 316	Deck	Each	Each

Deck Hinges



Part No.	Description	Finish	Fitting Type	UOM
G607S	Folding / Heavy duty	Stainless Steel 316	Deck	Each
G615S	Universal / Complete	Stainless Steel 316	Deck	Each
G615SQP	Universal / Complete	Stainless Steel 316	Deck	Each
G622S	Flat base	Stainless Steel 316	Deck	Each
G623S	Flat base	Stainless Steel 316	Deck	Each
G624S	Flat base	Stainless Steel 316	Deck	Each
G625S	Flat base	Stainless Steel 316	Deck	Each
G625SQP	Flat base	Stainless Steel 316	Deck	Each
G692S	Flat base	Stainless Steel 316	Deck	Each
G622BK	Flat base	Black / Nylon	Deck	Each
G626S	Concave base	Stainless Steel 316	Deck	Each
G674S	Concave base	Stainless Steel 316	Deck	Each
G675S	Hinge and socket	Stainless Steel 316	Deck	Each
G677S	Hinge and socket	Stainless Steel 316	Deck	Each

Deck Pins



G625PIN



G627PIN

Part No.	Description	Finish	Fitting Type	UOM
G625PIN	Quick release pin	Stainless Steel 316	Accessories	Each
G627PIN	Drop nose pin	Stainless Steel 316	Accessories	Each
G625LAN	155mm lanyard for G625PIN	Stainless Steel 316	Accessories	Each

Deck Mount

- ◆ Spring-loaded release button ejects eye for almost instant frame removal
- ◆ Stylish and unique design
- ◆ Use with G611S, G621S, G631SHD and G641SHD, see page 122



Part No.	Description	Finish	Fitting Type	UOM
G605S	Quick release	Nylon / Stainless Steel 316	Deck	Each

Side Mount

- ◆ Accepts all sizes of eye end



Part No.	Description	Finish	Fitting Type	UOM
G629S	Side	Nylon/Stainless Steel 316	Deck	Each

Universal Deck Mount

- ◆ Swivelling base fitting
- ◆ Three piece design allows 200° variation in mounting angle
- ◆ Fitting consists of three pieces which assemble into one fitting



Part No.	Description	Finish	Fitting Type	UOM
G603	Universal	Nylon/Stainless Steel 316	Deck	Each

A2 Stainless Steels Screws



Part no	Head Type	Size	Length mm	UOM
D408	Cheesehead	M4	12	Each
D409	Caphead	M5	12	Each
D404	Panhead	M5	15	Each
D412	Countersunk	M5	16	Each
D413	Countersunk	M5	25	Each
D419	Panhead	M5	25	Each
D421	Socket Caphead	M6	20	Each
D402	Countersunk	M6	25	Each
D407	Socket Caphead	M6	25	Each

Bendarc Tube Bender

- ◆ Bendarc Quick-Switch - gives strong bends with smooth, rounded corners
- ◆ Designed for wall or bench mounting and easy pull down use, Bendarc can bend 152mm to 300mm radius, depending on which dies are purchased
- ◆ Easy, pull-down use
- ◆ Wall mounting allows your body weight to help
- ◆ Quick and easy to switch sizes
- ◆ Constructed of boiler plate steel with bearing supported roller and powerful 998kg clamp
- ◆ Rollers are high density polymer for mark resistant contact with fine tubing finishes

Bendarc Unit

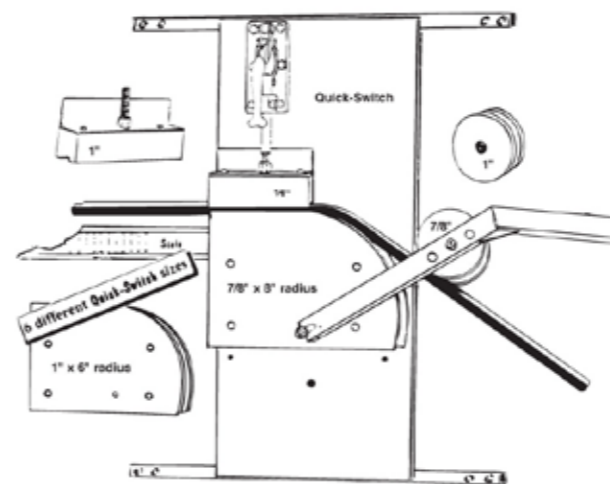

Part No.	Description	Tube Size: mm / in	Radius Die / Forming Block: mm / in	UOM
C996B	Tube Bender	22 / 7/8"	203 / 8	Each
C995	Tube Bender	25 / 1	203 / 8	Each
C995B	Tube Bender	25 / 1	254 / 10	Each
C997	Tube Bender	25 / 1	203 / 8 & 254 / 10	Each

Bendarc Spares

Part No.	Description	Tube Size: mm / in	Radius Die / Forming Block: mm / in	UOM
C996/8	Block only	22 / 7/8"	203 / 8	Each
C996/10	Block only	22 / 7/8"	254 / 10	Each
C996/12	Block only	22 / 7/8"	305 / 12	Each
C997/6	Block only	25 / 1	152 / 6	Each
C997/8	Block only	25 / 1	203 / 8	Each
C997/10	Block only	25 / 1	254 / 10	Each
C997/12	Block only	25 / 1	305 / 12	Each

Crown Arc Tube Bender

- ◆ The only crowner with gear drive
- ◆ Mounted on the wall, a table or on the side or rear of a truck, Crownarc puts a crown onto tubing
- ◆ Bends 19, 22 & 25mm outside diameter tubing using the same dies
- ◆ Dies and rollers are mounted on a backplate of boiler plate steel
- ◆ Rollers are high density polymer
- ◆ The center roller is fully adjustable

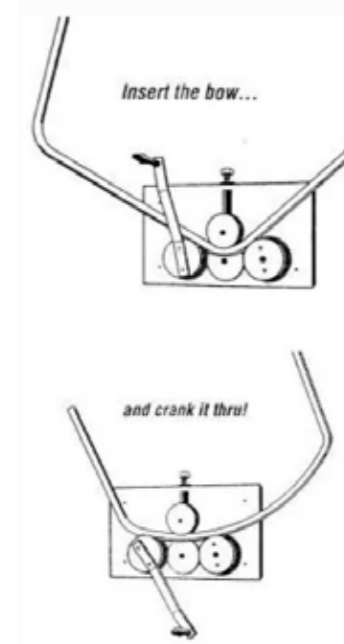

Part No.	Tube Size: mm / in	UOM
C998	19 / 3/4" 22 / 7/8" 25 / 1"	Each

Awning & Sprayhood Track

Bright polished metal and flexible plastic track used with Bainbridge International Keder sprayhood tapes for easy and compact fittings of covers.

- ◆ For marine and caravan use and permitting quick removal
- ◆ Various types of track used for awning and sprayhood application

Track

G512015 / G512, G512015BK / G512BK

- ◆ Works best with L575 & L575BK
- ◆ Highly flexible for easy installation
- ◆ Use flat or oval head screws to install (D371 or D355)



G535WT/95

- ◆ Unique low profile awning track system with polyester awning rope and sliding screw cover panel to hide attaching screws
- ◆ Premium grade extruded PVC with UV inhibitors
- ◆ Sleek and ultra-low profile

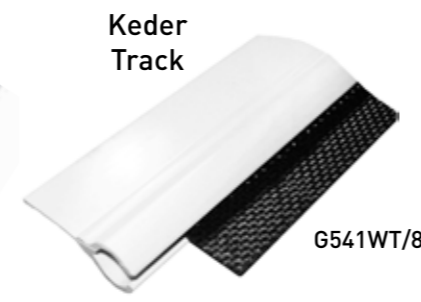

Part No.	Colour	Material	Use with	Inside Dims: mm	Length m	UOM
G512015	White	PVC extrusion	L575 or L575BK Keder	10.5	1.5	Each
G512015BK	Black	PVC extrusion	L575 or L575BK Keder	10.5	1.5	Each
G512	White	PVC extrusion	L575 or L575BK Keder	10.5	3	Each
G512BK	Black	PVC extrusion	L575 or L575BK Keder	10.5	3	Each
G513	White	PVC extrusion	L585 Keder Tape	9	2.4	Each
G535WT/95	White	PVC extrusion	L555 Keder Tape		2.4	Each
G541WT/8	White	PVC extrusion	L585 Keder Tape	9	2.4	Each
G520-8	Silver	Aluminium	L585 Keder Tape	9	2.4	Each

Track Fixings

Part No.	Finish	Head Type	Size	Pack Qty
D350	Stainless Steel 316	Panhead	No 4 x 10mm	100
D356	Stainless Steel 316	Pozi Panhead	M3 x 10mm	100
D370	Stainless Steel 316	Pozi Panhead	M3 x 16mm	100
D371	Stainless Steel 316	Countersunk	No 6 x 19mm	100

Keder Sprayhood Tapes

- ◆ Keder is durable and reinforced woven polyester tape welded to polyethylene core
- ◆ Easily slides into vinyl or plastic mouldings and tracks for marine, automotive and awning industries
- ◆ Ideal for sides of tents, awnings, lorry curtains and marine covers
- ◆ Full reels only - available in 100 and 300 metre reels

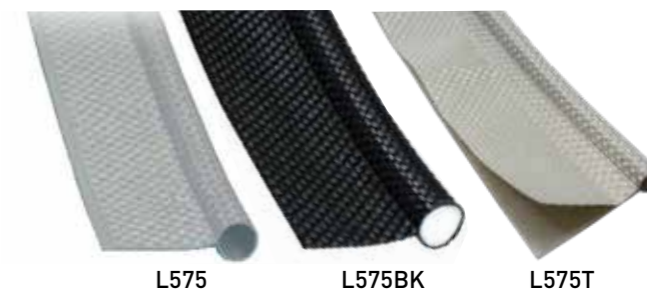

Part No.	Description	Colour	Diameter mm	Reel Length m	UOM
L575	Welded tongue	White	7.5	100	Metre
L575BK	Welded tongue	Black	7.5	100	Metre
L575T	Welded twin tongue	White	7.5	100	Metre
L585	Welded tongue	White	8.5	100	Metre
L585BK	Welded tongue	Black	8.5	100	Metre
Long Reels					
L575300	Welded tongue	White	7.5	300	Metre
L575BK300	Welded tongue	Black	7.5	300	Metre
L585300	Welded tongue	White	8.5	300	Metre
L585BK300	Welded tongue	Black	8.5	300	Metre

Keder Track Slide - Ball Style

- ◆ Allows quick and easy installation to many awning tracks
- ◆ Designed to suit both aluminium and vinyl track (not suitable G512)
- ◆ Potentially removes the need for awning ropes
- ◆ Ideal for making curtains that open and close



Part no	Description	Colour	UOM
A091WT	Nylon	White	Each

Spray Welt with Adhesive

- ◆ Functional spray welt manufactured from extruded foam rubber
- ◆ Ideal for almost all applications where a tight, waterproof seal is required
- ◆ P-section design ensures maximum efficiency
- ◆ Hi-tack adhesive with release paper on rear
- ◆ Ideal weather strip for sealing enclosures, dodgers, covers etc



Part No.	Colour	Edge Seal Width mm	Roll Length m	UOM
L705BKA	Black	34	15	Metre

Super Seal

- ◆ Manufactured from extruded foam rubber composition
- ◆ Suited to almost all applications where a tight, waterproof seal is required and when a panel or enclosure is clamped into place
- ◆ Ideal weather strip for sealing: enclosures, dodgers, covers etc
- ◆ Also perfect for bow corner and radar arches
- ◆ Sectional design ensures maximum efficiency



Part No.	Colour	Edge Seal Width mm	Roll Length m	UOM
L720BK	Black	44	20	Metre

Boat Top Fittings

- ◆ Boat Vent 2, used for last two decades adding value to covered boats by venting and tenting, preventing mildew and mould
- ◆ Moulded from the highest UV inhibited plastic
- ◆ Overhanging top to allow in less moisture Boat Vent 3 has additional teeth for a better grip

Boat Vents

- ◆ Fast installation - no screws needed
- ◆ Fits 19mm or 22mm tubing



Part no	Description	Material	Colour	UOM
G050BK	Boat Vent 2	Nylon	Black	Each
G050BU	Boat Vent 2	Nylon	Blue	Each
G050GY	Boat Vent 2	Nylon	Grey	Each
G050WT	Boat Vent 2	Nylon	White	Each
G048BK	Boat Vent 3	Nylon	Black	Each

Adjustable Support Pole with Cam Action

- ◆ Comes with three interchangeable tips:
- ◆ No. 1 - pole end fits No. 3 spur grommet
- ◆ No. 2 - soft vinyl tip similar to the foot
- ◆ No. 3 - with button snap accepts standard G142 socket, see page 134



Part No.	Material	Colour	Length m	UOM
G371	Aluminium	Silver	1 - 1.7	Each

Adjustable Awning / Cover Support Pole



Part No.	Material	Colour	Length m	UOM
G308	Aluminium	Silver	1.2 - 2.4	Each
G309	Aluminium	Silver	1.8 - 3.6	Each

Telescopic Cover Supports

- ◆ Anodised aluminium
- ◆ Ideal for wintering
- ◆ Prevents water stagnation in awningAllows quick and easy attachment on dodgers to guard rails, sailcover, marques, tents and awning structures

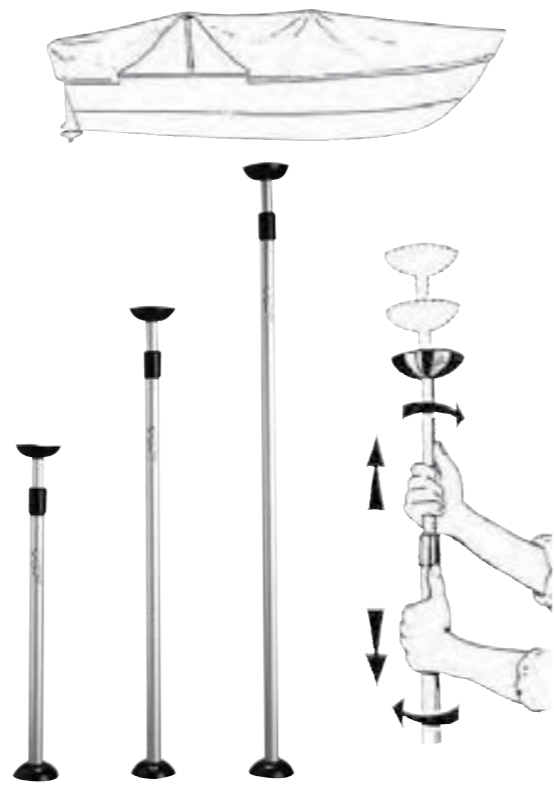

Part No:	Description	Colour	Height range: cm from to	UOM
AQM022812	Telescopic	Silver	66.5 - 102	??
AQM022814	Telescopic	Silver	86.5 - 151	??
AQM022816	Telescopic	Silver	125.5 - 202	??

Rubber Mooring Pole Base

- ◆ Rubber pad to protect and hold the pole in position without sliding
- ◆ Can be locked into the best position for the boat



Part No.	Material	Colour	UOM
G049BK	Nylon	Black	Each

Boat Cover Sockets

- ◆ Use one or more pairs of sockets with 40mm fiberglass batten to support boat cover
- ◆ Use No 8 flat or oval head screws
- ◆ Sockets are sold in pairs only



Part no	Material	Finish	Colour	UOM
G670	Die Cast / Chrome	Chrome	Silver	Pair

Sunblocker Clips

- ◆ Self insulated protective clip eliminating contact between metal tubular frame and clear plastic windows
- ◆ Two or three Sunblocker clips on metal frame tubing can give maximum protection against destruction of clear plastic windows, by reducing singeing, scorching and heat cracking

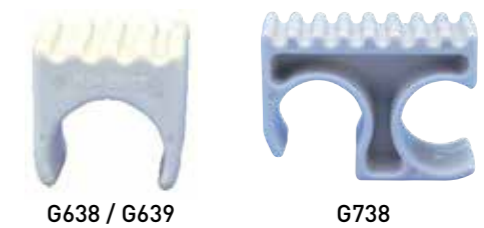

Part No.	Description	Material	Tube Ø mm	Colour	UOM
G638	Single	Nylon	22	White	Each
G639	Single	Nylon	25	White	Each
G738	Double	Nylon	22	White	Each

Sun Sox - Window Protectors

- ◆ Simple inexpensive protector to prevent windows resting on hot tubing
- ◆ Non-woven spun polyester cover - soft finish with velcro strip closure
- ◆ Simply wraps around tubing up to 37mm and secures to itself
- ◆ 1.8m lengths can be cut to match tube length



Part No.	Colour	Roll Length m	UOM
LS401BG	Burgundy	1.8	Each
LS401BK	Black	1.8	Each
LS401BU	Blue	1.8	Each
LS401GY	Grey	1.8	Each
LS401TN	Beige	1.8	Each

Please note: Colour representations shown are the closest approximate match permissible by print process. Customers should be aware that the colour of products will alter in appearance to the eye by the light and environment, e.g. bright blue environments will change yellow to greener shades.

Bainbridge Snap Fasteners

- ◆ These have a superior snap action and holding strength when needed
- ◆ The heavy duty construction assures a firm grip that will remain secure through years of use
- ◆ Self-piercing so no pre-punching is required
- ◆ Fastenings for boat, marine covers and canvas work



Snap Buttons



Part no	Colour	Pack Qty
G440	Nickel	100
G440BK	Black	100
G440SS	Stainless Steel	100

Snap Socket



Part no	Socket Ø mm	Colour	Pack Qty
G442	9.65	Nickel	100
G442BK	9.65	Black	100
G442SS	9.65	Stainless Steel	100

Snap Studs



Part no	Ø mm	Stem length mm	Finish	Pack Qty
G443	14.25	4.45	Nickel	100
G443BK	14.25	4.45	Black	100
G443SS	14.25	4.45	Stainless Steel	100

Snap Eyelet



Part no	Stem length mm	Colour	Pack Qty
G445	5	Nickel	100
G445BK	5	Black	100
G445SS	5	Stainless Steel	100

Snap Screw Stud



Part no	Colour	Stud Ø mm	Pack Qty
G451SS	Stainless Steel	10	100
G452SS	Stainless Steel	16	100

YKK® SNAD® Fasteners

- ◆ Unlike traditional metal trims, SNAD® is a plastic adhesive snap component.
- ◆ This product will not snag clothing or deteriorate from exposure to sunlight, sand, or dirt
- ◆ Plus, walking on SNAD® is pain free due to its unique dome shape
- ◆ Installation is simple, clean the surface where the snap is to be applied, peel off the protective paper backing, position and firmly hold the snap in place and release.
- ◆ No tools, no waiting, no splits, no holes!

SNAD® Studs - 25mm



Part no	Description	Colour	Dia mm	Pack Qty
G192BK	Flexible Base / Adhesive	Black	25	10
G192WT	Flexible Base / Adhesive	White	25	10
G196CL	Flexible Base / Adhesive	Clear	25	10
G194BK	Dome / Adhesive	Black	25	10
G194WT	Dome / Adhesive	White	25	10

SNAD® Studs - 40mm



Part no	Description	Colour	Dia mm	Pack Qty
G195CL	Flexible Base / Adhesive	Black	40	10
G195WT	Flexible Base / Adhesive	White	40	10
G190BK	Dome / Adhesive	Black	40	10
G190WT	Dome / Adhesive	Clear	40	10

SNAD® Sockets - 40mm



Part no	Description	Colour	Dia mm	Pack Qty
G191BK	Dome / Adhesive	Black	40	10
G191WT	Dome / Adhesive	White	40	10

Button & Eyelet Tool



- ◆ Two precisely spaced cavities
- ◆ Allows two buttons or eyelets to be installed at the same time
- ◆ A time saving tool
- ◆ One side is for 2 x G140 DOT® turnbuttons and the other for 2 x G145 DOT® turnbuttons

Part no	Description	UOM
C959	Button & Eyelet Tool	Each



DOT® Button Snap Fasteners

- ◆ Select the Press-N-Snap Tool (C360)
- ◆ Setting Punch (C954) to close Button Snap Fasteners (G140-G147 see page 134)



Part no	Description	Use with	UOM
C360	Press-N-Snap Tool	C361 die set	Each
C361	Die Set for Press-N-Snap Tool	G140 & G147	Each
C361BKW	Spare 'O' Ring for C360	G140 & G147	Each
C361GYW	Spare Washer for C360	G140 & G147	Each
C954	Setting Punch	G140, G141, G145 & G147	Each
C955	Setting Die C954	G140 & G141	Each
C956	Setting Die C954	G145, G146 & G147	Each



DOT® Button Snap Fasteners

- ◆ When superior snap action and holding strength is needed
- ◆ DOT® button snaps are the fastener to use
- ◆ Snap fastener's heavy duty construction assures a firm grip that will remain secure through years of use

DOT® Snap Button



Part No.	Material	Colour	Barrel Size mm	Pack Qty
G140	Nickel plated brass	Silver	5	100
G140BK	Nickel plated brass / Enamel	Black	5	100
G140BKM	Nickel plated brass / Enamel	Matte Black	5	100
G140BU	Nickel plated brass / Enamel	Pacific Blue	5	100
G140NV	Nickel plated brass / Enamel	Navy Blue	5	100
G140TST	Nickel plated brass / Enamel	Beige	5	100
G140WT	Nickel plated brass / Enamel	White	5	100
G141	Nickel plated brass	Silver	6.5	100
G140SS	Stainless steel	Silver	4.8	100
G141SS	Stainless steel	Silver	6.5	100

DOT® Snap Socket



Part No.	Material	Socket Type	Pack Qty
G142	Nickel plated brass	Regular action	100
G155	Nickel plated brass	Stiff action	100
G142SS	Stainless steel	Regular action	100

DOT® Snap Posts



Part No.	Material	Socket Type	Pack Qty
G145	Nickel plated brass	6.5	100
G146	Nickel plated brass	8	100
G147	Nickel plated brass	10	100
G145SS	Stainless steel	6.5	100



DOT® Snap Stud Base



Part No.	Finish / Colour	Stud Type	Pack Qty
G143	Nickel plated brass	Stud base	100
G144	Nickel plated brass	Stud deep base	100
G182	Nickel plated brass	Flangeless stud base	100
G143SS	Stainless Steel	Stud base	100
G148	Nickel plated brass	Stud reversible	100

DOT® Snap Stud Windshield Clip



Part No.	Finish / Colour	Stud Type	Pack Qty
G156	Nickel plated brass	Windshield clip 19mm	100
G157	Nickel plated brass	Windshield clip 22mm	100
G158	Nickel plated brass	Windshield stud clip	100

DOT® Snap Screw Stud



Part No.	Finish / Colour	Screw Type	Length mm	Pack Qty
G153	Nickel plated brass	Phillips machine screw	9.5	100
G151	Nickel plated brass	Phillips	10	100
G154	Nickel plated brass	Phillips machine screw	15.9	100
G151SS	Stainless steel	Phillips	10	100
G152	Stainless steel	Phillips	16	100
G1520S	Stainless steel	Oversized Phillips	16	100
G171	Stainless steel	Deep Phillips self tapper	12	100
G175	Stainless steel	Deep Phillips self tapper	20	100
G171FW	Plastic flexi washer	For eyelet, button or studs	-	100

Bainbridge Turnbutton Fasteners

- ◆ Traditional fastenings for boat, marine covers and canvas work
- ◆ Positive locking fasteners that never open accidentally
- ◆ Each is assembled with spring mechanism that holds fastener under tension in desired position until turned and released by hand
- ◆ Dependable even in the most difficult environments
- ◆ Can be used on hard and soft surfaces



Part no	Description	Prong Depth mm	Body Depth mm	Hole Centres mm	Finish	Pack Qty
G400	Turnbutton with Prong	7.5	7	-	Nickel	100
G403	Turnbutton	-	6	22.8	Nickel	100
G404	Turnbutton	-	8	22.8	Nickel	100
G406	Eyelet & Washer	5.5	-	-	Nickel	100
G406L	Eyelet & Washer	7	-	-	Nickel	100

Permalock Fasteners

- ◆ All manufactured from Dupont® non-corrosive, UV stabilised Zytel®
- ◆ Can be sewn or attached in place with flathead screws or rivets
- ◆ Recommend 2 x G145 / G147 eyelets (see page 134) as alternative to standard rivets



Part no	Description	Colour	Dimensions mm L x W x H	UOM
G160ABK	Backplate for stud	Black	34 x 10 x 1	Each
G160AWT	Backplate for stud	White	34 x 10 x 1	Each
G160BK	Stud with 2 screw base	Black	36 x 12 x 20	Each
G160WT	Stud with 2 screw base	White	36 x 12 x 20	Each
G161BK	Eyelet - 2 part	Black	28 x 22 x 1.5	Each
G161WT	Eyelet - 2 part	White	28 x 22 x 1.5	Each

Permalock Cutting Punch



Part no	Description	Colour	Fastener	UOM
C140	For use with Permalock fasteners	Stainless Steel	G161BK G161WT	Each

DOT® Commonsense Cutting Punches

- ◆ For best results use a rawhide mallet or Maul Master see page 160
- ◆ C950 for male fitting to fabric



Part no	Description	Use with	UOM
C950	Cutting Punch	G103 & G119	Each
C952	Hand Set Hex Head	G113, G115S & G116S	Each
C953	Cutting Punch	G130	Each



DOT® Commonsense Turnbutton Fasteners

- ◆ Traditional fastenings for boat, marine covers and canvas work
- ◆ These positive locking fasteners never open accidentally
- ◆ Each is assembled with a spring mechanism that holds the fastener under tension
- ◆ Combines secure fastenings with ease of use
- ◆ Dependable even in the most difficult environments
- ◆ Common Sense can be used on hard and soft surfaces

DOT® Commonsense Turnbutton Studs



Part no	Finish / Colour	Type	Base type	Pack Qty
G103	Nickel plated brass	Single set inc turnbutton & base plate	2 Prong	100
G100	Nickel plated brass	Single	2 Screw base	100
G103A	Nickel plated brass	Single	2 Prong	100
G106	Nickel plated brass	Single	15mm brass screw	100
G108	Nickel plated brass	Single	Rivet base	100
G101	Nickel plated brass	Double	2 Screw base	100
G108BP	Nickel plated brass	Backplate	Rivet base	100
G103BP	Nickel plated brass	Backplate - stud only	2 Prong	100
G101FW	Plastic	Flexiwasher for G100/G101	-	100

DOT® Commonsense Turnbutton Eyelets



Part no	Finish / Colour	Type	Prong	Pack Qty
G104	Nickel Plated Brass	Eyelet set	Regular	100
G105	Nickel Plated Brass	Eyelet set - prongs & plate set	Long	100
G104A	Nickel Plated Brass	Eyelet	Regular	100
G105A	Nickel Plated Brass	Eyelet	Long	100
G104BP	Nickel Plated Brass	Base plate - no slots	-	100
G105MW	Nickel Plated Brass	Base plate - 4-prong slots	-	100
G105FW	Plastic	Flexiwasher for eyelet	-	100



Lift-the-DOT® Studs



Part no	Finish / Colour	Type	Fixing/Prong	Pack Qty
G119	Nickel Plated Brass	Stud & backing plate set	2 prong	100
G120	Nickel Plated Brass	Stud & washer set	Rivet	100
G113	Nickel Plated Brass	Stud	Machine screw	100
G115S	Nickel Plated Brass	Stud	10mm Stainless Steel Screw	100
G116S	Nickel Plated Brass	Stud	15mm Stainless Steel Screw	100
G119A	Nickel Plated Brass	Stud	2 prong	100
G120A	Nickel Plated Brass	Stud	Rivet	100
G119BP	Nickel Plated Brass	Base plate - 2 prong slots	-	100
G120BP	Nickel Plated Brass	Washer for rivet stud	-	100

Lift-the-DOT® Windshield Stud

Part no	Finish / Colour	Type	Fixing/Prong	Pack Qty
G118	Nickel Plated Brass	Windshield Clip	22mm	100



Lift-the-DOT® Fasteners



Part no	Finish / Colour	Type	Prong	Pack Qty
G130	Nickel Plated Brass	Regular Socket Set	100	100
G130A	Nickel Plated Brass	Socket	4 x Regular	100
G130LP	Nickel Plated Brass	Socket	4 x Long	100
G130BP	Nickel Plated Brass	Base plate - 4 prong slots	-	100
G119FW	Plastic	Flexiwasher for eyelet	-	100

LOXX Fasteners

- ◆ A secure fastening solution that is lockable, easily detachable and prevents accidental opening.
- ◆ One-handed operation in one direction only, for fast assembly
- ◆ Easy to use, especially tear-proof, leak-proof and rust-proof
- ◆ 3 year guarantee, resists tensile forces over 1000 N, rounded surfaces
- ◆ Wide range of designs and finishes, including individual laser engraving, painting or printing
- ◆ Made in Germany



LOXX Metal Screws

- ◆ All screw threads are manufactured from stainless steel
- ◆ Head available in plated brass or stainless steel



Part no	Thread Material	Size mm	Head Finish	Pack Qty
L00593105098	Stainless Steel	10	Nickel plated	Each
L00593111000	Stainless Steel	10	Chrome plated	Each
L00593179098	Stainless Steel	10	Black chrome plated	100
L00438605098	Stainless Steel	12	Nickel plated	Each
L00438611000	Stainless Steel	12	Chrome plated	Each
L00438679098	Stainless Steel	12	Black chrome plated	100
L00885900000	Stainless Steel	12	Stainless steel	Each
L00719005098	Stainless Steel	16	Nickel plated	Each
L00719011000	Stainless Steel	16	Chrome plated	100
L00719079098	Stainless Steel	16	Black chrome plated	100
L00159005098	Stainless Steel	16	High head nickel plated	Each
L00159011000	Stainless Steel	16	High head chrome plated	Each
L00800305098	Stainless Steel	22	Nickel plated	100
L00800311000	Stainless Steel	22	Chrome plated	Each
L00800379098	Stainless Steel	22	Black chrome plated	Each

LOXX Metric Screw

- ◆ All screw threads are manufactured from stainless steel
- ◆ Head available in plated brass or stainless steel



Part no	Description	Size mm	Finish	Pack Qty
L00220405098	M5 / No nut	6	Nickel plated	100
L00220411000	M5 / No nut	6	Chrome plated	100
L00220802098	M5 / No nut	6	Stainless steel	Each
L00220205098	M5 / No nut	10	Nickel plated	100
L00220211000	M5 / No nut	10	Chrome plated	Each
L00220279098	M5 / No nut	10	Black chrome plated	Each
L00220305098	High Head / M5 / No nut	10	Nickel plated	100
L00220311000	High Head / M5 / No nut	10	Chrome plated	100
L00222802098	M5 / No nut	12	Stainless steel	Each
L00222005098	M5 / No nut	16	Nickel plated	100
L00222402098	M5 / No nut	16	Stainless steel	Each
L00222602098	M5 / No nut	25	Stainless steel	Each

LOXX Nut



Part no	Description	Material	Pack Qty
L00220902098	M5	Stainless steel	Each

LOXX Windshield Clip



Part no	Size mm	Finish / Material	Pack Qty
L00223000000	21	Stainless steel clip / brass, nickel plated pin	100
L00223100000	24	Stainless steel clip / brass, nickel plated pin	Each

LOXX Dowel for Piping Profile Rail



Part no	Finish / Material	Pack Qty
L00223300000	Black / plastic	Each

LOXX Fastener - Smooth

◆ Brass with a finish



L00511505000



L00511511000



L00511525000



L00511569000

Part no	Finish	Pack Qty
L00511505000	Nickel plated	Each
L00511511000	Chrome plated	Each
L00511525000	Antique brass	Each
L00511569000	Antique copper plated	50

LOXX Fastener - Smooth Head & Ring

◆ Brass with a finish



L00565805000



L00565879098

Part no	Finish	Pack Qty
L00565805000	Nickel plated	50
L00565879098	Black chrome plated	50

LOXX Fastener - XL with Long Washer

◆ Brass with a finish



L00514205000



L00514211000



L00514279098

Part no	Finish	Pack Qty
L00514205000	Gun metal	50
L00514211000	Gun metal	50
L00514279098	Black chrome plated	50

LOXX Fastener - Skull Head

◆ Brass with a finish



L00515163000 / L00515263000



L00518011000

Part no	Finish	Pack Qty
L00515163000	Nickel plated	50
L00515263000	Chrome plated	50
L00518011000	Chrome plated	Each

LOXX Smooth Head

◆ Brass with finish



Part no	Finish / Material	Pack Qty
L00511579098	Black chrome plated	Each

LOXX Smooth Head Extended

◆ Brass a with finish



L00673679098



L00673779098



L00831205000



L00831211000



L00831279098

Part no	Finish	Pack Qty
L00673679098	Chrome plated	50
L00673779098	Black chrome plated	50
L00831205000	Nickel plated	50
L00831211000	Chrome plated	50
L00831279098	Black chrome plated	50

LOXX Small Head

◆ Brass with a finish

Part no	Finish	Pack Qty
L00513405000	Nickel plated	50
L00513411000	Chrome plated	Each
L00513425000	Antique Brass plated	Each
L00513469000	Chrome plated	50
L00513479098	Black chrome plated	50



L00513405000



L00513411000



L00513425000



L00513469000



L00513479098

LOXX Big Head

◆ Brass with a finish or stainless steel

Part no	Description	Finish	Pack Qty
L00511549000	-	Gold plated	50
L00514005000	-	Nickel plated	Each
L00514011000	-	Chrome plated	Each
L00514025000	-	Antique brass plated	Each
L00514049000	-	Gold plated	50
L00514069000	-	Antique copper plated	50
L00514079098	-	Black chrome plated	50
L00886502098	-	Stainless steel	Each
L00514105000	With washer	Nickel plated	Each
L00514111000	With washer	Chrome plated	Each
L00514125000	With washer	Antique brass plated	Each
L00514149000	With washer	Gold plated	50
L00514169000	With washer	Antique copper plated	50
L00514179098	With washer	Black chrome plated	50
L00889102098	Hybrid	Nickel plated	50



L00514069000



L00514079098



L00886502098



L00514105000



L00514111000



L00514125000



L00514149000



L00514169000



L00514179098



L00889102098



L00511549000



L00514005000



L00514011000



L00514025000



L00514049000



LOXX Base Plate

- ◆ Brass with a finish



Part no	Finish	Pack Qty
L00592905000	Nickel plated	100
L00592911000	Chrome plated	100
L00592949000	Gold plated	100
L00592979098	Black chrome plated	Each
L00593005000	Nickel plated	Each
L00593011000	Chrome plated	100

LOXX Fastener Fabric Base

- ◆ Brass with a finish



Part no	Finish	Pack Qty
L09512105000	Nickel plated	Each
L09512111000	Chrome plated	100
L09512125000	Antique brass plated	100
L09512149000	Gold plated	100
L09512169000	Antique copper plated	100

LOXX Round Plate



Part no	Description	Finish	Pack Qty
L00599402098	Screw fix	Stainless steel	100
L00599502098	Glue fix	Stainless steel	100

LOXX Tools



Part no	Description	Use	Size mm	Pack Qty
L00449205000	Key mall wrench	-	9	Each
L00449500000	Key wooden handle	For washer of all upper parts	-	Each



Lacing Buttons

- ◆ Maximum cord size 5mm

Part no	Material	Colour	Dia & Height mm	Pack Qty
G045BK	Nylon	Black	12 / 10	100
G045WT	Nylon	White	12 / 10	100
G046BK	Nylon	Black	18 / 13	50
G046WT	Nylon	White	18 / 13	50
G055BK	Nylon	Black	18 / 13	50
G055WT	Nylon	White	18 / 13	50

Holdon® Clips

- ◆ Holdon® is a patented and reusable instant clip-on eyelets and tarp clip
- ◆ Ideal for securing all types of textiles, fabrics, substrates, polythene and other sheet products
- ◆ Ideal for customising shelters, emergency repairs to covers, shade sails, backdrops
- ◆ Perfect for adding new fixing points/guy lines and securing tarpaulins
- ◆ Available in midi (tested to 100kg) and mini style (tested to 45kg)

- ◆ Stronger than traditional eyelets
- ◆ For flexible material up to 1.5mm (mini) / 5mm (midi) thickness
- ◆ No tools needed



Part no	Description	Colour	Dimensions mm L x w x h	Weight g	*Loading Capacity kg	UOM
A160WT	Midi - max material thickness: 5mm	White	70 x 40 x 18.5	20	100	10
A161WT	Mini - max material thickness: 1.5mm	White	40 x 35 x 10	12.5	45	10

* Loading capacity only a guide and will depend on material type and thickness

Sew on Cover Hooks & Eyelets

- ◆ Injection moulded nylon
- ◆ Sew through plastic with straight stitch sewing machine
- ◆ Can be used alone, or together with lacing and shockcord see page 92



Part no	Description	Colour	Pack Qty
A068BK	Eyelet	Black	100
A068WT	Eyelet	White	100
A069BK	Hook	Black	100
A069WT	Hook	White	100

Cover Hooks

- ◆ Manufactured from stainless steel wire
- ◆ Hand sew or use speedy rivets D050N and backplates
- ◆ Suitable for max 10mm shockcord see page 92



Part no	Description	Colour	Pack Qty
B401S	Hook	Stainless steel	10
D050N	Speedy Rivet	Nickel plated	100 sets

Rivet on Cover Hooks

- ◆ Injection moulded nylon
- ◆ Use D337 rivets see page 53
- ◆ Suitable for max 6mm shockcord



Part no	Description	Colour	Pack Qty
A071	Hook	White	10

Sew on Fairlead Eyelets

- ◆ Injection moulded nylon
- ◆ Sew through plastic eyelets
- ◆ Can be used alone, or with lacing and shockcord
- ◆ Allows quick and easy attachment on dodgers to guard rails, sailcover, marques, tents and awning structures



Part no	Description	Colour	UOM
A170	Eyelet	Dark grey	Each
A172	Eyelet with wheel	Dark grey	Each



Eye Strap

- ◆ Used for cord / lacing direction

Part no	Material	Colour	Dim: L x H mm	Pack Qty
G203S	Stainless steel	Silver	37 x 12	10
G204N	Nickel plated brass	Silver	40 x 14	10



Groz-Beckert - Sewing Machine Needles

- ◆ Groz-Beckert sewing machine needles, always produced using latest technology, maximum precision, and have always boasted top-notch quality
- ◆ Through regular further developments and innovations, Groz-Beckert remains a leading brand

Chromium 134 D

- ◆ Wide triple-edge cut in leather
- ◆ Straight seam
- ◆ Thread slightly elevated
- ◆ Stitch holes are wide open
- ◆ Suitable for medium to long stitches

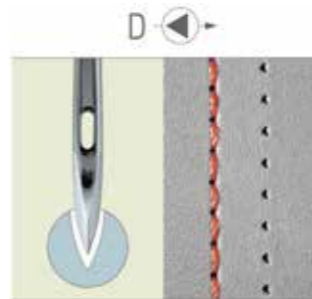

Part No.	Needle Size	Point Style	Coating	Length butt to eye: mm	Shank Dia: mm	Pack Qty
NC13400D090	90/14	D	Chromium	33.9	2	10
NC13400D100	100/16					
NC13400D110	110/18					
NC13400D120	120/19					
NC13400D130	130/21					

Chromium 134 R

- ◆ Normal round point
- ◆ Slightly sharp
- ◆ Suitable for woven fabrics, coated materials, soft clothing leather and artificial leather
- ◆ Standard point for lockstitch

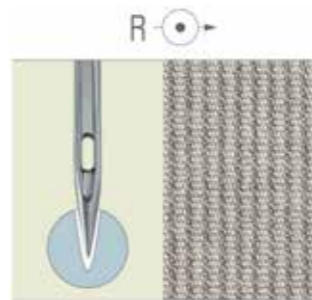

Part No.	Needle Size	Point Style	Coating	Length butt to eye: mm	Shank Dia: mm	Pack Qty
NC13400R090	90/14	R	Chromium	33.9	2	10
NC13400R100	100/16					
NC13400R110	110/18					
NC13400R120	120/19					
NC13400R130	130/21					
NC13400R140	140/22					

Chromium 134-135 D

- ◆ Wide triple-edge cut in leather
- ◆ Straight seam
- ◆ Thread slightly elevated
- ◆ Stitch holes are wide open
- ◆ Suitable for medium to long stitches

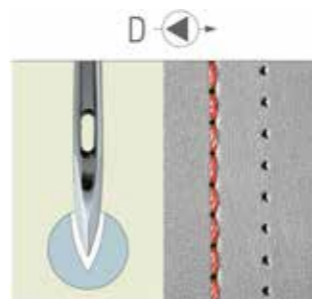

Part No.	Needle Size	Point Style	Coating	Length butt to eye: mm	Shank Dia: mm	Pack Qty
NC13435D090	90/14	D	Chromium	38.1	2	10
NC13435D100	100/16					
NC13435D110	110/18					
NC13435D120	120/19					
NC13435D130	130/21					



Chromium 134-135 R

- ◆ Normal round point
- ◆ Slightly sharp point
- ◆ Suitable for woven fabrics, coated materials, soft clothing leather and artificial leather
- ◆ Standard point for lockstitch

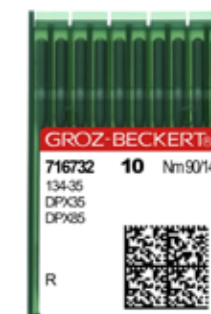
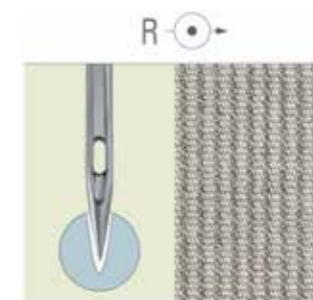

Part No.	Needle Size	Point Style	Coating	Length butt to eye: mm	Shank Dia: mm	Pack Qty
NC13435R090	90/14	R	Chromium	38.1	2	10
NC13435R100	100/16					
NC13435R110	110/18					
NC13435R120	120/19					
NC13435R130	130/21					

Chromium 135x17 R

- ◆ Normal round point
- ◆ Slightly sharp point
- ◆ Suitable for woven fabrics, coated materials, soft clothing leather and artificial leather
- ◆ Standard point for lockstitch

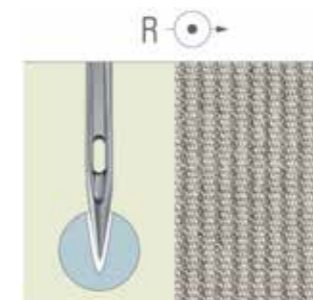

Part No.	Needle Size	Point Style	Coating	Length butt to eye: mm	Shank Dia: mm	Pack Qty
NC13517R090	90/14	R	Chromium	38.9	2	10
NC13517R100	100/16					
NC13517R110	110/18					
NC13517R120	120/19					
NC13517R130	130/21					

Chromium 794

- ◆ Normal round point
- ◆ Slightly sharp point
- ◆ Suitable for woven fabrics, coated materials, soft clothing leather and artificial leather
- ◆ Standard point for lockstitch

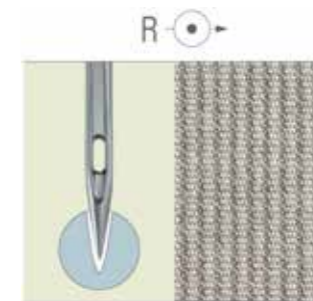

Part No.	Needle Size	Point Style	Coating	Length butt to eye: mm	Shank Dia: mm	Pack Qty
NC79400R140	140/22	R	Chromium	60	2.5	10
NC79400R160	160/23					
NC79400R180	180/24					
NC79400R200	200/25					
NC79400R230	230/26					
NC79400R250	250/28					

GROZ-BECKERT®**Titanium Nitride 134 R**

- ◆ Normal round point
- ◆ Slightly sharp point
- ◆ Suitable for woven fabrics, coated materials, soft clothing leather and artificial leather
- ◆ Standard point for lockstitch
- ◆ Titanium nitride coating makes needle more wear-resistant, particularly protecting against damage around the point and eye

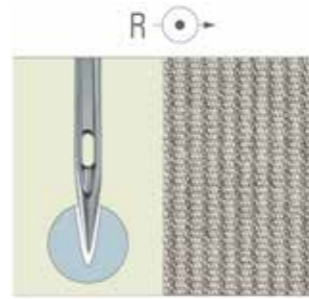

Part No.	Needle Size	Point Style	Coating	Length butt to eye: mm	Shank Dia: mm	Pack Qty
NG13400R100	100/16	R	GEBEDUR® Titanium Nitride	33.9	2	10
NG13400R120	120/19					

Titanium Nitride 134-35 R

- ◆ Normal round point
- ◆ Slightly sharp point
- ◆ Suitable for woven fabrics, coated materials, soft clothing leather and artificial leather
- ◆ Standard point for lockstitch
- ◆ Titanium nitride coating makes needle more wear-resistant, particularly protecting against damage around the point and eye

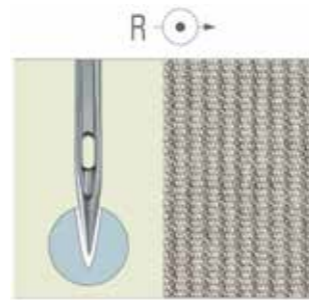

Part No.	Needle Size	Point Style	Coating	Length butt to eye: mm	Shank Dia: mm	Pack Qty
NG13435R100	100/16	R	GEBEDUR® Titanium Nitride	38.1	2	10
NG13435R120	120/19					

Titanium Nitride 134-35 R

- ◆ Normal round point
- ◆ Slightly sharp point
- ◆ Suitable for woven fabrics, coated materials, soft clothing leather and artificial leather
- ◆ Standard point for lockstitch
- ◆ Titanium nitride coating makes needle more wear-resistant, particularly protecting against damage around the point and eye

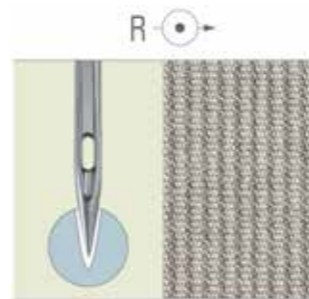

Part No.	Needle Size	Point Style	Coating	Length butt to eye: mm	Shank Dia: mm	Pack Qty
NG13517R110	110/18	R	GEBEDUR® Titanium Nitride	38.9	2	10
NG13517R130	130/21					

**Hand Sewing Needles**

Hand Sewing Needles by W. Smith & Son are the best sailmaker's needles available. Forged in England from cast steel with reduced edges, they also feature triangular points and sharp edges to cut through whatever fabric you are using.

A long eye makes threading easier and the triangular shape opens larger holes in the fabric to cut down on chafe problems when a long length of twine is repeatedly pulled through.

All needles are hand-made and hand polished for ease of use.

Note: Needle size increases as the size number decreases. The #16 needle is good for most work, but as a general rule use larger needles for sewing through many layers of fabric and smaller needles for seaming work.

Assorted Sailmakers Needles

- ◆ Hand made
- ◆ Feature flat spots on shaft to enable use of pliers to pull needle through



Part No.	Diameter mm	Length mm	Size	Pack Qty
C005	-	-	13 - 19	5

Assorted Sailmakers Needles

- ◆ Assorted pack of 10 contains needles sizes #14-18.
- ◆ Needles come in a waterproof tube, perfect for onboard storage



Part No.	Length mm	Pack Qty
C021	Assorted	10
C022	Assorted	20

Sailmakers Needles

Part No.	Diameter mm	Length mm	Size	Pack Qty
C010	3.25	89	10	25
C012	2.64	81	12	25
C013	2.34	79	13	25
C014	2.03	76	14	25
C015	1.88	72	15	25
C016	1.63	69	16	25
C017	1.42	65	17	25
C018	1.22	62	18	25
C019	1.02	49	19	25

Nickel Plated Sailmakers Needles

- ◆ Exclusive to Bainbridge
- ◆ Self-lubricating making it easier to sew which requires less force to penetrate the substrates
- ◆ Nickel coating adds hardness and provides a stiffer point and stronger eye meaning it is less likely to bend and break
- ◆ Less likely to rust in the marine environment



Part No.	Diameter mm	Length mm	Size	Pack Qty
C013N	2.34	79	13	25
C014N	2.03	76	14	25
C015N	1.88	72	15	25
C016N	1.63	69	16	25
C017N	1.42	65	17	25
C018N	1.22	62	18	25

All Purpose Hand Sewing Needles

- ◆ Good general pack of needles for hand sewing repairs
- ◆ Canvas, carpet, leather, sacks, sail and upholstery

Part No.	Needle Ref. No.	Use	Pack Qty
C007	1	Canvas	Each
	2	Carpet	
	3	Leather	
	4	Sacks	
	5	Sail	
	6	Upholstery	
	7	Upholstery	



Stitchers & Stitcher Needles

- ◆ Choose between the Speedy Stitcher (C916) and Stitching Awl (C910US)

Speedy Stitcher

- ◆ The Speedy Stitcher is a hand-operated sewing machine which is suitable for use with most heavy fabrics and leather
- ◆ Speedy Stitcher needles (C917C8 and C917ST8) come individually



C916



C917C8

C917ST8



C918/30

Part No.	Description	Use with	UOM
C916	Speedy Stitcher Handle	C917C8 C917STB C918/30	Each
C917C8	Curved Needle	C916	Each
C917STB	Straight Needle	C916	Each
C918/30	Coarse polyester thread	C916	Each

Stitching Awl

- ◆ Stitching awl needles C9105, C9106 and C9108 come in packs of 3
- ◆ Ideal for sewing repairs on leather and canvas
- ◆ Awl set comes complete with two straight needles, waxed white thread and combination driver



C910US



C9105

C9108



C9106



C911WT

Part No.	Description	Use with	UOM
C910US	Awl Set	C9105 C9106 C9108	Each
C9105	No. 5 Straight Needles	C910US	3
C9106	No. 6 Curved Needles	C910US	3
C9108	No. 8 Heavy Duty Straight Needles	C910US	3
C911WT	White replacement thread	C910US	Each



Seaming and Roping Palms

- ◆ Excellent quality sailmakers palms
- ◆ Handcrafted in England
- ◆ These seaming and roping palms are made for long lasting wear and comfort
- ◆ Many styles have moulded rawhide palm protections

Left Hand Seaming



C027



C025



C037



C029



C033

Part No.	William Smith No:	Use	UOM
C027	2½	Seaming	Each
C025	3	Seaming	Each
C037	9	Seaming	Each
C029	11	Seaming	Each
C033	15	Seaming	Each

Right Hand Seaming



C023



C024



C026



C028



C032



C036

Right Hand Roping



C030



C034

Part No.	William Smith No:	Use	UOM
C023	2	Seaming	Each
C026	2½	Seaming	Each
C024	3	Seaming	Each
C036	9	Seaming	Each
C028	11	Seaming	Each
C032	15	Seaming	Each
C030	12	Roping	Each
C034	16	Roping	Each

Repair Kits

- ◆ Includes sailmaker's palm, wax, tube of 10 needles and thread



Part No.	Type	UOM
C038	Adjustable Right Palm	Each
C038L	Adjustable Left Palm	Each

Ocean Sail Repair Kit

Sturdy zip sailcloth holdall containing the following:

- ◆ 1 x General Purpose Kit Bag
- ◆ 1 x William Smith Palms No.11
- ◆ 1 pack of Sailmakers Needles 20 Assorted No. 14-19
- ◆ 5m of 12mm Standard Weight webbing
- ◆ 5m of 25mm Heavy Weight webbing
- ◆ 10m of 100mm Slit Sailcloth
- ◆ White Insignia Tape/Draft Stripe
- ◆ 2 x Awls
- ◆ 20 x Black Pushpins
- ◆ 1 x 15mm Double Sided Tape 50m
- ◆ 1 x Fiskars Scissors Lightweight 1005148
- ◆ 2 x Rings 30mm x 5mm Welded
- ◆ 1 x Waxed Sewing Thread
- ◆ 1 pack of Sail Repair Patches Assorted Sizes
- ◆ 1 x Twisted Whipping Twine



Part No.	Type	UOM
C980	Ocean Repair	Each



GP Sewing Machine Oil

- ◆ Oil blended from the highest quality solvent refined mineral oils
- ◆ Includes selected performance enhancing additives
- ◆ Very pale colour
- ◆ Oxidation inhibitors
- ◆ Low odour and staining
- ◆ Excellent penetration of bearings



Part No.	Volume: L	UOM
R015260001	1	Each
R015260005	5	Each

Thread Lubricant

- ◆ High performance thread lubricant



Part No.	Type	Volume ml:	UOM
M305	Thread Lubricants	950	Each

Thread Lubricator Box

- ◆ Lubricator box fixes securely to sewing machine to lubricate thread as you sew
- ◆ Does not require removal from sewing machine for refilling
- ◆ Magnet on base holds lubricator firmly in place



Part No.	Type	UOM
C061	Thread Lubricants	Each

Oil Bottle

- ◆ Application bottle has screw-on cap to prevent accidental spills when bottle is on its side



Part No.	Type	Volume (ml)	UOM
C063	Sewing Machine Oil	120	Each

Hot Knives & Blades

Designed to seal synthetics, woven and knit fabrics, and cut and weld rope, cord and webbing.



Bainbridge Hot Knife

- ◆ Cuts and weld rope ends, cord and webbing
- ◆ Seals edges with minimum smoke and no singed edges
- ◆ Effortless cutting - no mess, no fuss
- ◆ Spring loaded safety trigger on/off switch
- ◆ Quick heating
- ◆ Pack contains Bainbridge hot knife C857 and blade C857B, plus brass wire cleaning brush, element tensioner key and instruction manual



Part No.	Description	Voltage	Watts	Heats To	UOM
D857D	Hot Knife & Blade Set	230	60	568°F	Each
C857	Hot Knife	230	60	568°F	Each
C857B	Blade	-	-	568°F	Each

Engel Hot Knife & Blade

Part No.	Description	Voltage	Watts	Heats To	UOM
C850	Hot Knife & Blade	220	60	537°C/ 1000°F	Each
C852	Blade	-	-	-	Each



Bainbridge Hot Tool

- ◆ Light weight easy-to-hold tools with blade included
- ◆ Heating element slides inside the selected tip attachment
- ◆ Allows very efficient use of heat
- ◆ Replacement blades available for each style



Part No.	Description	Handle Length: mm	Overall Length: mm	Heats to: °C / °F	Voltage	Watts
C860	Light Duty	89	152	450 / 850	110	18
C861	Heavy Duty	127	241	565 1050	110	18

Replacement Blades for Bainbridge Hot Tool



Part No.	Description	UOM
C862	Blade for C860 - Light Duty	Each
C865	Blade for C861 - Heavy Duty	Each

Seam Rippers & Cutters, Thread Snips, Scissors & Shears

Scissors, seam rippers and cutters used for a variety of jobs in sailmaking and covermaking applications

Seam Rippers & Cutters



C906

Part No.	Length mm	Type	UOM
C906	120	Large / Heavy Duty	Each

Thread Snips



C553



C554

Part No.	Brand	Style	Length mm	UOM
C553	Wiss	Metal	-	Each
C554	Wiss	Plastic	-	Each

Scissor Sharpener / Tuner

- ◆ Ceramic rod restores scissors to precise cutting edge
- ◆ For left and right handed scissors



Part No.	Type / Hand	UOM
C561	Left or Right	Each

FISKARS®

Scissors



C907



C909



C908

Part No.	Length mm	Type	Hand	UOM
C907	215	Lightweight	Right	Each
C909	245	Standard	Right	Each
C908	215	Lightweight	Left	Each

Bainbridge

Bainbridge Shears

- ◆ Teflon coated for cutting kevlar



Part No.	Length mm	Type / Hand	UOM
C912	260	Right Handed	Each



Wiss - Edge Shears



Part No.	Wiss No.	Hand	Length mm	UOM
C550-10	1225	Right	254	Each
C550-12	1226	Right	305	Each

Wiss - Industrial Shears



Part No.	Wiss No.	Hand	Length mm	UOM
C551-7	27	Right	178	Each
C551-8	28	Right	203	Each
C551-9	29	Right	229	Each

Wiss - Heavy Duty Shears



Part No.	Wiss No.	Hand	Length mm	UOM
C552-10	20	Right	254	Each
C552L-10	20	Left	254	Each
C552-12	22	Right	305	Each

Wiss - Extra Heavy Duty Shears



Part No.	Wiss No.	Hand	Length mm	UOM
C555-10	20W	Right	254	Each
C555-12	22W	Right	305	Each

Closing Pliers

- ◆ Closing pliers for all sizes

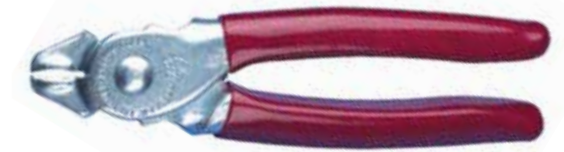

Part No.	Use with	UOM
C449	B449 - B453	Each

Cable/Wire Cutters

- ◆ Precision cable cutters by Felco
- ◆ Swiss made
- ◆ Designed to cut wire rope.
- ◆ Max cable 5mm
- ◆ Not suitable for cutting chain



Part No.	Max Cutting Size mm	UOM
C970	5	Each

Nicopress Sleeves - Tools

- ◆ The finest and most accurate hand-closing tools for Nicopress sleeves



Part No.	Length mm	Type	Use With	UOM
C962N	51	64CGMP	B544N-B546N	Each



OLFA® Cutters

OLFA® have been making cutters and blades in Japan for over 50 years. The OLFA name is synonymous for quality, performance and innovation with the original snap-off blade invented by the OLFA® founder, Yoshio Okada in 1956.

All Purpose Heavy Duty Knife

- ◆ Economy cutter
- ◆ High-impact ABS handle
- ◆ Extended stainless steel blade channel
- ◆ Pre-loaded with one strip of LB 18mm standard blades



Part No.	Description	Width: mm	Replacement Blade	UOM
OLFBNAL	Auto-lock	18	OLFLB10 OLFLB10B OLFLBB10B OLFLBB50B OLFLFB5B	Each

X-Design™ Pro Knife

- ◆ Gives exceptional sharpness and cutting power with die-cast handle
- ◆ Rubber wraparound grip prevents slipping, so considerable force can be applied to cut tough materials
- ◆ Minimises hand fatigue
- ◆ Aluminium die-cast construction is robust and corrosion-resistant, yet light



Part No.	Description	Width: mm	Replacement Blade	UOM
OLFMXPAL	Auto-lock	18	OLFLB10 OLFLB10B OLFLBB10B OLFLBB50B OLFLFB5B	Each

18mm Snap-off Replacement Blades

- ◆ Steel snap-off blades - 8 segments per 100mm strip
- ◆ Blades for 18mm cutters



Part No.	Description	Blade type	Blade width: mm	For use with	UOM
OLFLB10	Endurance Silver	Snap-Off	0.5	OLFBNAL OLFMXPAL	Loose pack of 10
OLFLB10B	Endurance Sliver	Snap-Off	0.5	OLFBNAL OLFMXPAL	Blister pack of 10
OLFLBB10B	Excel Black™ Ultra-Sharp	Snap-Off	0.5	OLFBNAL OLFMXPAL	Blister pack of 10
OLFLBB50B	Excel Black™ Ultra-Sharp	Snap-Off	0.5	OLFBNAL OLFMXPAL	Blister pack of 50

18mm Snap-off Replacement Speed Blades

- ◆ The blade is coated with fluorine which enables less drag and faster cutting
- ◆ Blades for 18mm cutters



Part No.	Description	Blade type	Blade width: mm	For use with	UOM
OLFLFB5B	Speed Blade	Snap-Off	0.5	OLFBNAL OLFMXPAL	Blister pack of 5

18mm Insulation Serrated Blades

- ◆ Wave-shaped edge cuts slippery hard-to-cut materials, such as rope
- ◆ Blades for 18mm cutters



Part No.	Description	Blade type	Blade width: mm	For use with	UOM
OLFLWB3B	Serrated	Solid	0.5	OLFBNAL OLFMXPAL	Blister pack of 3

28mm Rotary Blades for Rotary Cutters

- ◆ Rotary blade that will cut various materials including paper, textiles, leather and more
- ◆ Made from high quality tungsten carbide
- ◆ Blades undergo an advanced production process that results in excellent sharpness and long life

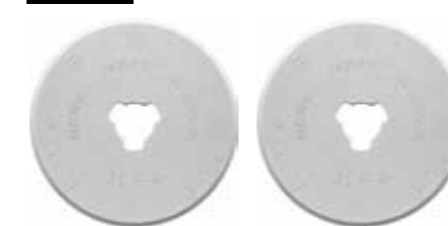

Part No.	Description	Blade Type	Blade width: mm	UOM
OLFRB2810	Rotary	Solid	1	Pack of 10
OLFRB282	Rotary	Solid	1	Pack of 2

Duluxe Rotary & Snap off Blade Disposal Case

- ◆ Specially designed disposal case for the OLFA® Excel Black blades and all sharps including rotary blades
- ◆ Used blades can be stored in the case prior to safe disposal
- ◆ Ensures the safe disposal of used blades
- ◆ For 9mm & 18 mm snap-off blades
- ◆ For use with OLFA® LB & LBB blades



Part No.	Description	Blade Size	UOM
OLFDC2	Storage of used blades	Up to 60mm Rotary	Each

Cloth Clamps



Part No.	Jaw Opening mm	UOM
C515R	25	Each
C516R	51	Each
C517R	76	Each

Heavy Duty Cloth Clamps

- ◆ Cloth Clamps have a heavy-duty steel construction and powerful spring mechanism
- ◆ Featuring soft jaw pads to prevent damage to the workpiece
- ◆ Comfortable grips for easy opening, closing and adjusting



Part No.	Jaw Opening: mm	UOM
C5025	25	Each
C5050	50	Each
C5075	75	Each

Awls

- ◆ Awls enable pushpins to keep cloth in position when measuring and marking



Part No.	Colour	Size mm	UOM
C900	Yellow	100	Each
C901	Yellow	130	Each

Pushpins

- ◆ Pushpins help to keep cloth in position when measuring and marking



Part No.	Colour	Pin Length mm	Overall Length mm	Pack Qty
C903BK	Black	15	28	100
C903FP	Hot Pink	15	28	100

Staplers & Removers



Part No.	Style	UOM
C519	Staple Remover	Each
C758	Rexel R56 Plier	Each

Staples



Part No.	Used For	UOM
D724	P6C, T5-6	Box
D732	C758	Box of 5000
D733	C758	Box of 5000

Leather

Genuine Marine Grade sailmakers soft chrome leather. Used in corner reinforcement and final finishing.

- ◆ 1.6 - 2.0mm - average thickness
- ◆ Smooth one side
- ◆ Suede finish on opposite side
- ◆ Average Hide size: 20ft²



Part No.	Style	Size mm	UOM
E160	Sheet	305 x 610	Each
E161	Hide	-	Foot Square

Seaming Tools

- ◆ The Wrist-Saver roller's patent pending design allows for proper positioning of your arm, wrist and hand into a neutral, relaxed working position
- ◆ The design allows you to use the power of your whole arm and conserve energy
- ◆ Keeps your wrist in a more comfortable position and your arm moves in a natural motion



Part No.	Diameter mm	Weight kg	UOM
EVMR02143	50.8	0.81	Each
EVMR05200	36.5	0.34	Each
C523	31.0	0.42	Each

Bench Knife

- ◆ Flexible polished steel blade
- ◆ Suitable for cutting and trimming leather and other thick material
- ◆ Securely held to wooden handle



Part No.	Blade Length mm:	UOM
C507	115	Each

Revolving Hand Punch

- ◆ For cover and canvas work
- ◆ Punches holes from 2.0 - 4.5mm



Part No.	Size mm	UOM
C125	230	Each

Heavy Duty Punch

- ◆ Revolving hand punch for canvas and cover work
- ◆ Punches holes from 2.4 - 4.8mm



Part No.	Size mm	UOM
C350	230	Each

Revolving Punch - Replacement Tubes

Part No.	Style	Size mm	UOM
C3501	2.4	1	each
C3502	2.8	2	each
C3503	3.2	3	each
C3504	4	4	each
C3505	4.4	5	each
C3506	4.8	6	each

Punches

- ◆ Hole punches used for grommets and inox ring system
- ◆ Manufactured to imperial sizes



Part No.	Size mm	Type	UOM
C101	3.2	Hole Punch	Each
C102	4.0	Hole Punch	Each
C103	4.8	Hole Punch	Each
C104	6.3	Hole Punch	Each
C105	7.9	Hole Punch	Each
C106	9.5	Hole Punch	Each
C107	11.1	Hole Punch	Each
C108	12.7	Hole Punch	Each
C109	14.3	Hole Punch	Each
C110	15.9	Hole Punch	Each
C111	17.5	Hole Punch	Each
C112	19	Hole Punch	Each
C113	20.6	Hole Punch	Each
C114	22.2	Hole Punch	Each
C116	25.4	Hole Punch	Each
C117	28.6	Hole Punch	Each
C118	32.0	Hole Punch	Each
C119	34.9	Hole Punch	Each
C120	38.1	Hole Punch	Each
C122	44.5	Hole Punch	Each

Hammers

Traditional sailmaking tool used with punches, hole cutters, grommet dies and wherever a cushioned hit is desired, now offered in a heavy weight 1.8kg (4lb), larger face style.

Maul Master

- ◆ Special shock absorbing, no slip rubber grip
- ◆ Special nylon compound striking surface
- ◆ Machined from aircraft aluminium



Part No.	Size mm	Weight kg	UOM
C234	254	2	Each

Raw Hide Mallets

- ◆ Malleable iron head fitted with cylindrical faces of compressed rawhide
- ◆ Head provides the weight for the blow and the rawhide faces absorb the shock whilst transferring the force to the item being struck without fear of damage
- ◆ Ideal where a heavy blow is required combined with a relatively small striking area
- ◆ Used as a general-purpose soft-faced hammer



C530



C531



C530R

Part No.	Face Dia mm	Weight kg	UOM
C530	44	1.23	Each
C531	50	1.9	Each
C530R	-	-	Each

Cutting Boards

- ◆ Cutting pads made from reinforced vinyl



Part No.	Colour	UOM
C501	Black	Each

Pattern Material

- ◆ Economical, flexible and stable pattern material
- ◆ The ideal material to make on site patterns for awnings and any type of cover
- ◆ Can also be used to make sail bags and accessories



Part No.	Roll Length m	Roll Width mm	Style	UOM
FP072CL	50	1830	Clear	Metre
FP072NB	200	1830	Blue	Metre
FP072SB	200	1830	Silver & Black	Metre
MYL35003	30	1220	Opaque	Metre

Lofting & Measuring Battens

- ◆ Fibreglass lofting battens available in 12 x 9 or 25 x 8 in various lengths
- ◆ Ideal for splining sail edges



Cross section C914/5



Cross section C920/2/4

Part No.	Length m	Sections mm	UOM
C914	5	12 x 9	Each
C915	10	12 x 9	Each
C920	12.2	25 x 8	Each
C922	18.3	25 x 8	Each
C924	30.5	25 x 8	Each

Measuring Tools

- ◆ For both covermaking and sailmaking.



C705



C713



C710

Part No.	Length m	Type	Colour	UOM
C705	30	Steel Tape	Black	Each
C713	30	Fibreglass Tape	Orange / Yellow	Each
C710	1	Aluminium	Silver	Each

Marking Tools

- ◆ For both covermaking and sailmaking.



C933

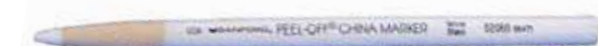

ZMARKERWT



ZPENCILBU



ZPENCILW2

Part No.	Type	Colour	Pack Qty / UOM
C933	Chalk	White	Box of 12
C933S	Chalk Sharpener	Yellow	Each
ZMARKERWT	China Marker	White	10
ZPENCILBU	Washable Pencil	Blue	10
ZPENCILW2	Washable Pencil	White	10

Knee Pads



Part No.	Type	Colour	UOM
C904	Knee Pads	Grey	Pair



Spray Adhesive

- ◆ An extremely versatile spray adhesive that permits either a temporary or permanent bond with a new "low mist" formula



Part No.	Size (ml)	UOM
J959A	500	Each

3M Adhesive Remover

- ◆ A specially blended solvent that provides easy cleanup of most types of adhesive and quickly removes waxes, road tars, grease, oil and similar materials
- ◆ Will not harm vinyl or fabrics when properly used
- ◆ Always try on a small area of similar material before use on a sail or cover
- ◆ Easy to apply
- ◆ Non-toxic
- ◆ Non-allergenic
- ◆ Much safer than acetone



Part No.	Liquid Measure (ml)	UOM
M040	946	Each



Rockeze Spray Maintenance & De-Watering Fluid

- ◆ A light hydrocarbon solvent treated with the most advanced rust and corrosion inhibitors, dewatering agent and friction modifiers
- ◆ Superior penetrating and light anti rust capabilities
- ◆ Excellent dewatering properties
- ◆ Limitless applications from freeing rusty bolts to protecting the finest machined part
- ◆ Extremely high searching power ensures release of all rust bound part



Part no	Description	Volume ml	UOM
R004070000240	Aerosol	300	Each

Rock Oil Silicone Protector

- ◆ Multi-functional spray for protection and lubrication
- ◆ Specially developed to give instant and lasting protection, as well as a shine, to vinyl, paintwork and plastics
- ◆ Particularly effective on black metal work
- ◆ May also be used on glass and Perspex, and as a non-staining lubricant on linkages and locks
- ◆ Do not spray onto a surface to be glued or painted



Part no	Description	Volume ml	UOM
R014481000240	Aerosol	400	Each

Rock Oil Water Resistant 2 Grease

- ◆ Premium quality long life grease for use in all anti-friction, high load and extreme water or even saturated operating conditions
- ◆ Also withstands high temperature environments
- ◆ Excellent water resistance ensuring maximum grease life and extending lubrication intervals
- ◆ De-watering properties enables application to saturated surfaces
- ◆ Anti-corrosion agents protects and extends the working life of components
- ◆ Extreme Pressure (EP) additives provide protection against premature wear
- ◆ Versatile lubricant with a wide temperature range
- ◆ Water Resistant 2 can be applied by hand, or by using a standard grease gun
- ◆ Can be applied directly onto wet surfaces



Part no	Description	Volume g	UOM
R064070000400	Tub	400	Each

Rock Oil White Spray Grease

- ◆ Repels water
- ◆ Prevents component seizure
- ◆ Ultimate protection in automotive, commercial, industrial and marine applications



Part no	Description	Volume ml	UOM
R0640400004	Aerosol	400	Each

YKK® – Zippy Cool

- ◆ Help to extend the life of zipper teeth
- ◆ Specially formulated cleaning and lubricating system
- ◆ Effective cleaning and lubricating of all types of metal, coil and plastic zippers
- ◆ Kit comes with: cleaning fluid to remove harmful dirt, sand and salt deposits and wax lubricating stick
- ◆ Remove harmful dirt, sand and salt deposits – great for marine zippers



Part No.	Cleaner volume ml:	Lubricant volume g:	Style	UOM
M030	59	14	Cleaning Fluid and Wax Lubricant	Each
M031	59	-	Cleaning Fluid	Each
M032	-	14	Wax Lubricant	Each

Seam Sealer

- ◆ Protects sewn seams
- ◆ Does not change the look or feels of the fabric



Part No.	Liquid Measurements (ml)	UOM
M216	118	Each

Seam Kote 4

- ◆ Waterborne urethane coating which exhibits excellent durability, flexibility & washability
- ◆ Lightfast and UV resistant
- ◆ Abrasion and impact resistant
- ◆ Does not prevent mould & mildew
- ◆ Good adhesion to a variety of substrates
- ◆ Contains no aromatic solvents
- ◆ Fast drying and easy to clean
- ◆ Keep from freezing



Part No.	Volume l:	UOM
M150	3.8	Each

Fabsil Seam Sealer

- ◆ Colourless, waterproof, dries to a clear finish and permanently bonds to outdoor fabric
- ◆ Restores all fabric and gear while remaining washable
- ◆ Ideal for sealing and repairing tents and awnings, outdoor clothing, rucksacks and tarpaulins
- ◆ Lay clean and dry article flat
- ◆ Use the included applicator brush for easy application
- ◆ For seams: Apply a thin, even film.
- ◆ For repairs: Create a backing using easy-to-remove tape, fill hole and spread solution roughly 0.5cm beyond the tear and remove tape when dry
- ◆ Allow to dry thoroughly before using or packing items away



Part no	Description	Volume ml	UOM
GRFAB61	Tube	30	Each



Sail Cleaner

- ◆ Professional formulation cleaner
- ◆ Quick and effective cleaning of boat and yacht sails
- ◆ Removes general dirt, grime, grease, traffic/pollution film and mould
- ◆ Safe on sail stitching and component parts
- ◆ 100% biodegradable and harmless to marine life



Part No	Type	Volume	UOM
M5307	Spray	750ml	Each



Canopy Cleaner

- ◆ Designed to allow simple and effective cleaning of canopies, dodgers and seat covers
- ◆ Extremely effective and user friendly
- ◆ Superb results without the need for sustained scrubbing



Part No	Type	Dilution ratio	Volume	UOM
M5110	Concentrate	1:10	1 litre	Each

Fabric Protector

- ◆ Designed for use on all canopies, dodgers, fabric seating and even carpets
- ◆ Provides a water repellent surface, less susceptible to staining
- ◆ Active silver ion ingredient assists in reducing mould, mildew or algae growth



Part No	Type	Volume	UOM
M5205	Spray	500ml	Each

Fabsil Universal Fabric Protector

- ◆ Spray-on treatment replicates original water-repellent finish found on all kinds of outdoor gear and equipment
- ◆ Has been trusted by professionals and outdoor enthusiasts for years
- ◆ High-performance, silicone-based waterproofing treatment
- ◆ Suitable for use on all outdoor gear
- ◆ Apply directly to clean fabric
- ◆ Spray from roughly 10-15cm away
- ◆ Ensure good, even coverage
- ◆ Wipe away any excess product, including droplets, with a clean cloth
- ◆ Allow the treated material to dry completely before use



Part no	Description	Volume ml	UOM
GRFAB03	Aerosol	400	Each
GRFAB04	Aerosol	600	Each
GRFAB05	Liquid	1000	Each
GRFAB06	Liquid	2500	Each
GRFAB07	Liquid	5000	Each

Fabsil Gold Universal Fabric Protector

- ◆ Super-concentrated, easy-to-apply waterproofing treatment
- ◆ More than twice as concentrated as standard Fabsil
- ◆ Available in compact aerosol or 1 litre can
- ◆ Refreshes repellency of seams, zips and other tricky-to-proof areas
- ◆ Higher silicone content than any other Fabsil products
- ◆ Apply directly onto clean fabric from roughly 10-15cm away
- ◆ Ensure good, even coverage
- ◆ Wipe away any excess product with a clean cloth
- ◆ Allow all the treated material to dry completely before use



Part no	Description	Volume ml	UOM
GRFAB16	Aerosol	200	Each
GRFAB13	Liquid	1000	Each

303 Protectants

- ◆ 303 is excellent for preventative maintenance, with UV screen that reduces fading and degradation due to ozone, acid rain and weather



M010/10

M012

Part No.	Size (ml)	UOM
M010/10	236	Each
M012	3800	Each

Leather & Vinyl Protector

- ◆ For application to any leather or vinyl surface
- ◆ Gives protection against damage from sun's UV rays
- ◆ Reduces staining



Part No	Volume	UOM
M5801	100ml	Each

Fabsil Gear Cleaner & Wipes

- ◆ Removes dirt from outdoor fabrics, leaving fewer water-absorbing impurities to impair performance
- ◆ Allows water-repellent treatments already on the fabric to work as intended
- ◆ Cleaning before applying waterproofing treatments makes them more effective
- ◆ Brush or wipe off any loose dirt
- ◆ Dilute the cleaner as per bottle instructions
- ◆ Apply using a clean cloth or soft brush
- ◆ Rinse thoroughly with clean water
- ◆ Leave to dry naturally
- ◆ Allow the treated material to dry completely before use



Part no	Description	Volume ml	UOM
GRFAB54	Liquid	500	Each
GRFAB58	Liquid	1000	Each
GRFAB59	Wipes x 15	-	Each

Boat Shampoo

- ◆ User friendly, high quality boat wash
- ◆ For use throughout the season



Part No	Type	Dilution ratio	Volume	UOM
AQMCBS1000	Concentrate	1:100	1 litre	Each
AQMCBS5000	Concentrate	1:100	5 litre	Each

Hull Cleaner

- ◆ Hugely effective to remove virtually any stain from GRP hull
- ◆ Waterline pollutants, streak marks and airborne pollutants easily removed



Part No	Type	Dilution ratio	Volume	UOM
AQMCHC1000	Concentrate	1:10	1 litre	Each

Cutting Compound

- ◆ Highly effective and user friendly
- ◆ Leaves professional shine on surface of GRP gelcoat or painted surface
- ◆ For best results use with polishing machine (max 1800rpm)



Part No	Volume	UOM
AQMCCC1000	1 litre	Each

GRP Deck Cleaner

- ◆ Highly effective cleaner for moulded GRP non slip deck areas
- ◆ Especially effective in removing stains from airborne pollutants and greening caused by damp conditions
- ◆ Can be used undiluted for stubborn stains



Part No	Type	Dilution ratio	Volume	UOM
AQMDCDC0500	Concentrate	1:10	500ml	Each

Polish & Wax

- ◆ Gives ultra high gloss finish on any GRP or painted surface
- ◆ Fast and simple to apply by hand
- ◆ Professional finish guaranteed



Part No	Volume	UOM
AQMCPW0500	500ml	Each

Glass Cleaner

- ◆ High alcohol content and added ammonia for superior cleaning performance
- ◆ Also effective for cleaning stainless steel and aluminium railings and fittings



Part No	Type	Volume	UOM
AQMCGC0750	Spray	750ml	Each

Crystal Vision

- ◆ Hydrophobic glass sealant
- ◆ Specially formulated so that glass remains crystal clear for a long period of time
- ◆ Deflects bad weather and the environment



Part No	Volume	UOM
M5403	250ml	Each

IMAR Strataglass

- ◆ Window polish and cleaners made by IMAR
- ◆ Gently cleans all plastics without scratching
- ◆ Leaves a lustrous shine that resists fogging, repels dust and eliminates static
- ◆ Resists finger marking
- ◆ Contains no abrasives or harsh chemicals
- ◆ Leaves a smooth, clean and greaseless shine



M2214 M2224

Part No.	Size (ml)	Type	UOM
M2214	118	Cleaner	Each
M2224	118	Polish	Each

Metal Polish & Restorer

- ◆ Used to remove tarnishing from chrome, stainless steel and aluminium surfaces
- ◆ Leaves a high gloss finish on stainless steel
- ◆ Leaves a clean as new finish on aluminium
- ◆ Can also be used to restore finish on aluminium hulled boats



Part No	Volume	UOM
AQMCMPO175	175ml	Each

Iosso Mould & Mildew Remover

- ◆ Removes mould, mildew, tough dirt and some stains
- ◆ Use on fabrics, vinyl, plastic, fibreglass and wood
- ◆ Colour and fabric safe
- ◆ Gentle to skin, no harmful vapours
- ◆ Just add water to the biodegradable non toxic, non chlorine powder



Part No.	Size kg	UOM
M212	0.34	Each

LENGTH

To Convert	Into	Multiply By
Inches	Millimetres	25.4
Feet	Metres	0.3048
Yards	Metres	0.9144
Miles	Kilometres	1.609
Mil (1/1000 of inch)	Millimetres	0.0254
Mil (1/1000 of inch)	Microns	25.4

AREA

To Convert	Into	Multiply By
Square Yards	Square Metres	0.836

WEIGHT

To Convert	Into	Multiply By
Ounces	Grammes	28.35
Pounds	Kilogrammes	0.4536

FABRIC

To Convert	Into	Multiply By
Sailmakers Ounces	Ounces /Square Yard	1.263
Sailmakers Ounces	Grammes/Square Metre	42.83
Ounces/Square Yard	Sailmakers Ounces	0.792
Ounces/Square Yard	Grammes/Square Metre	33.91

GLOSSARY

316 Stainless Steel: A grade of stainless steel ideal for the marine environment.

AIRX: Bainbridge's brand name for a superior range of performance spinnaker nylons.

Bias: A diagonal across a piece of fabric at 45° to the warp and fill.

Carbon: An extreme performance fibre used extensively in composite engineering and the sailcloth market.

Creep: The property of fibres to gradually stretch under a constant load.

Crimp: Length or waviness added to a yarn when it is woven over-and-under in a piece of fabric. Crimp can contribute to the elongation of a fabric under load.

Dacron: DuPont's trade name for polyester fibre.

Denier: Weight of 9000 metres of yarn in grams.

DTex: Weight of 10,000m of yarn in grams.

DIAX: Bainbridge's brand name for laminates.

Dyneema®: Super strong polyethylene fibre made by DSM, up to 40% stronger than aramid

fibres. Also resistant to UV and moisture.

Elongation: The difference between the length of a stretched sample and its initial length; expressed in 1/100ths of an inch.

Fibre: Strand of material used to spin into a yarn.

Fill: The yarn or fibre running across the width of the fabric at right angles to the warp.

Gsm: Weight in grams of a square metre of cloth.

Kevlar: DuPont's trade name for a family of high-strength aramid fibres.

Laminate: A layered fabric made by bonding scrim and/or taffetas to one or two plies of film.

Modulus: The measure of stretch or elasticity of a fabric. High Modulus = low stretch.

MPEX: Bainbridge's brand name for a range of multi-purpose spinnaker fabrics.

Polyester: A strong, reliable fibre ideal for cruising, racing laminates and woven sailcloth.

Primary Yarn Direction: The orientation (warp or fill) in which a fabric is the most stretch resistant.

Sailmakers Ounces (sm oz): Weight of a 36" x 28.5" piece of cloth.

Scrim: Non woven, formed sheet of yarns held together with resin.

Spectra: A highly modified polyethylene fibre developed by Allied Corp.

Taffeta: A light woven fabric used on laminates to add durability and abrasion resistance.

Tenacity: The breaking strength of a yarn or fabric stated in force per unit of the cross-sectional area.

Tensile Strength: The ability of a fibre, yarn or fabric to resist breaking under tension.

Technora: Aramid fibres with lower modulus but better flex properties than Twaron®.

Thread line: The direction of the yarns.

Titanium: Low density, high strength metal and resistant to corrosion.

Twaron®: Family of aramid fibres made by Akzo.

Vectran®: A liquid crystal polymer (LCP) fibre 10 times stronger than aluminium.

Warp: The yarn or fibre running the length of a fabric.

Cutting & Nesting

Bainbridge can plot or cut from your drawings or designs as a ntv or a dxf file and take those and prepare them as cutting files - these are the fully nested instruction sets suitable for plotting and cutting. Our nesting software ensures that material wastage is reduced to the mathematical minimum – the iterative algorithms used are the best available and fully automatic.

The choice of how much of the package you wish to use is entirely yours. Our intention is to be an extension of your team allowing increased capacity and providing a dependable service.

See the inside front cover for full details of what materials we can cut.



Design

Using our in-house expertise in design alongside industry leading software covering many aspects of CAD/CAM, Bainbridge can work alongside you to deliver the very best results. Our aim is to allow you to meet your customers' expectations. We can take concepts, measurements, or drawings on to provide all the advantages of automated design and manufacture.

We can provide design services for:

- ◆ Sail design – from boat measurements and/or sail measurements
- ◆ Digitising of templates
- ◆ Metal fittings, and output suitable for 3D printing
- ◆ Plastic fittings, and output suitable for 3D printing

We will work closely with you to provide bespoke solutions that best fit your manufacturing needs - Bainbridge delivers a design service that is fast and efficient.

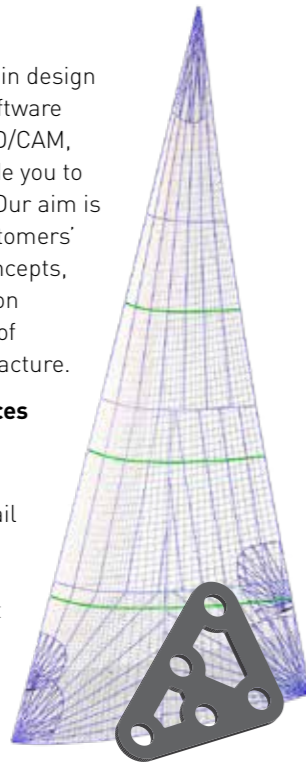

In-house Tensile Testing

All our sailcloth products undergo rigorous testing using our Lloyd Instruments single pillar machine with an annually certified and fully electronic load cell. Further it can apply compressive force to be able to measure a material's ability to take load in any direction - an example is testing the hardness of plastics or metals. Therefore, the same machine can test materials of many sorts in most products, so if you have a need to test something before using it in manufacture, you only have to ask.

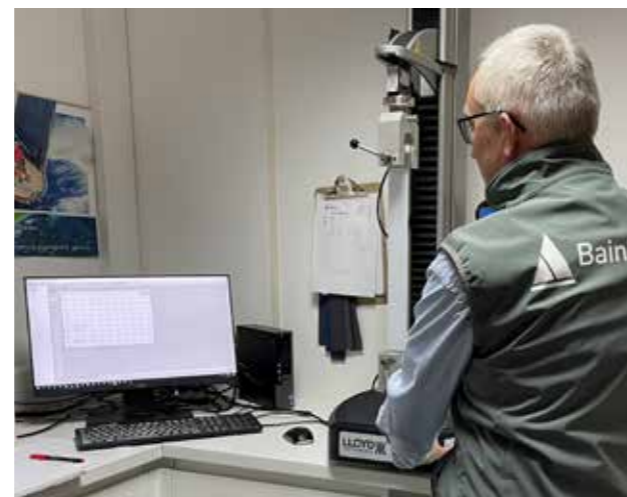

Slitting & Converting Services

Bainbridge specialises in precision slitting and rewinding of a wide range of materials. This includes both roll-to-roll and cut lengths.

We take pride in our ability to work alongside our customers R&D departments in the strictest confidence trialling new and revised materials giving valuable advice on all aspects of the slitting and rewinding process. Our skilled staff have the experience and depth of knowledge to add value to our customers products.

Bainbridge has worked with many types of materials over the years and include but are not limited to:

- ◆ Wovens – polyester and hybrid sailcloth, nylons, and acrylic cover fabrics
- ◆ Non-wovens – protective sheeting, and including those for medical purposes and PPE
- ◆ Films and PVC
- ◆ Laminates
- ◆ Advanced flexible materials

Bainbridge has custom-built machinery which includes



a computerised tension control system which ensures that the same parameters are accurately reproduced in subsequent production runs giving the customer absolute confidence in the consistent quality of repeat orders.

Over the years, we have handled on behalf of our customers many different materials and fabrics to input rolls of various widths and weights to output various widths in one single pass operation.

Heat Slitting

As well as using conventional cold slitting techniques Bainbridge can heat slit synthetic materials (usually woven) where it is important to seal the cut edges to stop fraying or fibre contamination.

Batch Traceability

Bainbridge also offers full batch traceability together with customised labelling to exact customer specifications using the your own specialised packaging materials as required.

Commercial & Intellectual Property Rights

We fully appreciate that Intellectual Property Rights (IPR) are very important to your business, and that the type of information that would be supplied to us to offer these services will often be of a sensitive commercial nature and we will be more than happy to sign Non-Disclosure Agreements (NDA) with you as required. We do this as a matter of course in our normal business so are familiar to being bound by these types of constraints.

Storage, Distribution & Logistics

From our modern premises on the south coast of England, Bainbridge can offer clean dry storage facilities to our customers for raw materials together with finished goods.

Distribution of our customers products can also be organised to their scheduled instructions for deliveries within the UK, Europe and beyond.

We have a fleet of vans that deliver daily on a local basis and further afield as required.



Part No.	Page	Part No.	Page	Part No.	Page	Part No.	Page	Part No.	Page	Part No.	Page	Part No.	Page
06R	12, 26	A032	33	A313	32	B123	77	B531	36	C038	152	C324	52
06R30	12, 26	A033	33	A315	32	B125	77	B532	36	C038L	152	C325	52
06REC	27	A035BK	6, 7	A4121	30	B126	79	B536	34	C040	150	C326	52
08R	12, 26	A038	35	A4121S	30	B127	76	B540	72	C041	120	C350	159
08R30	12, 26	A039	35	A4122	30	B129	34	B541	72	C061	152	C3501	159
08REC	27	A043	51	A4161	30	B130	34	B542	72	C063	152	C3502	159
10DECI	27	A044	51	A4161	30	B131	34	B542N	72	C101	159	C3503	159
10DECO	27	A045	51	A4161S	30	B133	72	B543	72	C102	159	C3504	159
10DXSTECI	27	A048	51	A4162	30	B134	72	B543N	72	C103	94, 159	C3505	159
10EC002	27	A049	51	A4162	30	B135	72	B544	72	C104	159	C3506	159
10R	12, 26	A052	50	A4162	30	B136	72	B544N	72	C105	94, 159	C360	133
10R30	12, 26	A054	53	A4201	30	B137	72	B545N	72	C106	94, 97, 159	C361	133
10REC	27	A055	53	A4201S	30	B138	72	B546	72	C107	94, 97, 159	C361BKW	133
12R	12, 26	A059	53	A4202	30	B140	72	B546N	72	C108	94, 97, 159	C361GYW	133
12REC	27	A062	53	A511	36	B153	72	B547	72	C109	94, 97, 159	C407	75
14R	12, 26	A068BK	92, 145	A512	36	B154	72	B549	72	C110	94, 97, 159	C408	75
14REC	27	A068WT	92, 145	A513	36	B155	72	B605	36	C111	94, 97, 159	C409	75
15CT	26	A069BK	92, 145	A514	36	B156	72	B610	37	C112	159	C410	75
15CT100	26	A069WT	92, 145	A515	35	B158	72	B610S	37	C113	159	C411	75
15CTECI	27	A0701WT	101	A516	35	B170	76	B611	37	C114	94, 97, 159	C412	75
15CTECO	27	A0702WT	101	A517	35	B171	76	B611N	37	C116	159	C413	75
15CTST	26	A071	145	A518	35	B172	76	B611SW	37	C117	159	C414	75
15CTST100	26	A073	101	AQM010106	100	B174	76	B617S	37	C118	159	C449	93, 155
15DNECO	27	A074	101	AQM010107	100	B191	76	B617S	102	C119	159	C501	160
15DNEC1	27	A075	101	AQM010108	100	B196	76	B632	37	C120	159	C5025	158
15DXSTECI	27	A076	101	AQM010109	100	B197	76	B637	102	C122	159	C5050	158
15DXSTECIWT	27	A076HD	101	AQM010110	100	B204	76	B701	36	C125	159	C507	159
15EC002	27	A079BK	101	AQM022812	130	B2075	75	B702	36	C140	137	C5075	158
15EC006	27	A082	27	AQM022814	130	B2075C	75	B703	36	C234	160	C515R	158
16HCP	26	A084	101	AQM022816	130	B2076	75	B710	36	C301	94	C516R	158
16R	12, 26	A085	101	AQM025BK2	100	B2095	75	B816	50	C302	94	C517R	158
16REC	27	A086	101	AQM025BU2	100	B2095C	75	B845	52	C303	94	C519	158
20CV062	25	A087	101	AQM025GY2	100	B2096	75	B847	52	C303MB2	97	C523	106, 159
20CV080	25	A088	101	AQM025NB2	100	B2105	75	B907N	51	C303MB3	97	C530	160
20CV08020	25	A089	101	AQM025RD2	100	B2106	75	B909	50	C303MH1	96	C530R	160
20CV107	25	A089WT	101	AQM025WT2	100	B2108	75	B910	50	C303MH2	96	C531	160
20CV125	25	A091WT	129	AQM027403	35	B2118	75	B912N	50	C303MS	96	C550-10	155
20EC002	27	A095BK	102	AQM027554	35	B214	76	B913	50	C303P	97	C550-12	155
20EC006	27	A095WT	102	AQM027755	35	B218B	77	B914N	50	C303RRGT	96	C551-7	155
20EC010	27	A096BK	102	AQM027906	35	B219	76	BC08S	26	C303SWI	96	C551-8	155
20REC	27	A096WT	102	AQM054722	37	B220	76	BC10S	26	C304	94	C551-9	155
25CTJM	27	A097BK	102	AQM054723	37	B221	76	BC12S	26	C304FS	94	C552-10	155
30CEC	27	A097WT	102	AQM054726	37	B225	76	BC14S	26	C304MS	96	C552-12	155
30CT024	12, 26	A101	93	AQM054727	37	B225B	77	BC16S	26	C304P	97	C552L-10	155
30CT024R	12, 26	A102	93	AQM5107	53	B225BB	77	BC20S	26	C304RRGT	96	C553	154
30CT031	12, 26	A105	93	AQM5110	53	B226B	77	BCB042	38	C304SWI	96	C554	154
30CT031R	12, 26	A106BK	93	AQM5115	53	B226BB	77	BCB050	38	C305	94	C555-10	155
30CT044	12, 26	A107	6, 7	AQM5120	53	B227	76	BCB070	38	C305MS	96	C555-12	155
30CT044R	12, 26	A107	32	AQM514BK	83	B228	76	BCB100	38	C305P	97	C561	154
30CT052	12, 26	A108	6, 7	AQM514BU	83	B229	76	BCR070	38	C305RRGT	96	C705	161
30CT052R	12, 26	A108	32	AQM514GY	83	B229B	77	BCR100	38	C305SWI	96	C710	161
30CTEC h	27	A109	6, 7	AQM514RD	83	B248	77	BR042	38	C306	94	C713	161
40CEC	27	A109	32	AQM514WT	83	B250	77	BR050	38	C306MS	96	CL211MK1AN	58
40CT	26	A114	6, 7	AQMCSB1000	165	B303	29	BR070	38	C306P	97	CL211MK1VB	58
40CTST	26	A114	32	AQMCSB5000	165	B303	34	C005	149	C306RRGT	96	CL211MK2	58
A000	28	A116	6, 7	AQMCCC1000	166	B307	31	C007	150	C306SWI	96	CL211MK2AN	58
A001	28	A116	32	AQMCCDC0500	166	B308	31	C010	149	C307	94	CL211MK2ANS2	58
A002	28	A117	6, 7	AQMCGC0750	166	B309	31	C012	149	C307MS	96	CL211MK2S2	58
A004	28	A117	32	AQMCHC1000	165	B401S	92, 145	C013	149	C307P	97	CL212	54
A005	28	A118	6, 7, 35	AQMCMPO175	166	B449	93	C013N	149	C307RRGT	96	CL212A	54
A006	28	A118	32	AQMCPW0500	166	B450	93	C014	149	C307SWI	96	CL212BP	54
A006MBK	31	A122BK	101	AQMTT01	83	B451	93	C014N	149	C308	94	CL212BPP	54
A007	31	A125BK	101	B006	31	B452	93	C015	149	C308MS	96	CL212PR	54
A008	31	A134BK	102	B008	31	B453	93	C015N	149	C308P	97	CL213	57
A008MBK	31	A140	93	B009	31	B461	93	C016	149	C308RRGT	96	CL214	57
A009	31	A141	93	B010	31	B462	93	C016N	149	C308SWI	96	CL214W	54
A011	31	A142BK	101	B011	33	B463	93	C017	149	C309	94	CL214WPPR	54
A012	31	A150	27	B012	33	B464	93	C017N	149	C309MS	96	CL215	56
A013	31	A151	27	B013	33	B504	36	C018	149	C309P	96	CL215W	56
A014	31	A159BK	101	B014SS	33	B505	36	C018N	149	C309RRGT	96	CL217MK1	61
A015	31	A160WT	145	B015SS	33	B506	36	C019	149	C309SWI	96	CL217MK1AN	61
A016	32	A161WT	145	B016SS	33	B507	36	C021	149	C310MS	96	CL217MK2	61
A016S	32	A170	145	B035	33	B508	36	C022	149	C310P	97	CL217MK2AN	61
A017	32	A172	145	B036	33	B510	35	C023	151	C310RRGT	96	CL218MK1	61
A017S	32	A188A	35	B037	33	B511	35	C024	151	C310SWI	96	CL218MK1AN	61
A018	32	A300BK	29	B044	32	B512	35	C025	151	C311MS	96	CL218MK2	61
A018S	32	A300WT	29	B087	101	B513	35	C026	151	C311P	97	CL218MK2AN	61
A019	32	A302	28	B101	33	B514	35	C027	151	C311RRGT	96	CL219	57
A019S	32	A303BK	29	B102	33	B515	35	C028	151	C311SWI	96	CL219AN	57
A023	34	A303WT	29	B103	33	B516	35	C029	151	C312MS	96	CL220	57
A024	34	A305BK	29	B110	34	B517	35	C030	151	C312P	97	CL220AN	60
A026	34	A305SS	29	B114	76	B518	36	C032	151	C312RRGT	96	CL222AN	60
A027	34	A305WT	29	B117	76	B519	36	C033	151	C312SWI	96	CL223	59
A028	34	A306BK	29	B118	76	B520	36	C034	151	C321	52	CL223W	59
A031	33	A306SS	29	B119	76	B528	36	C036	151	C322	52	CL2245	57
A031C	33	A310	32	B121	76	B529	36	C037	151	C323	52	CL228	57

Part No.	Page	Part No.	Page	Part No.	Page	Part No.	Page	Part No.	Page	Part No.	Page	Part No.	Page
C933S	161	CL230	61	CL704AN	58	D008NX	94	D857D	153	E512L	113	E561WT	109
C950	137	CL230AN	61	CL710	59	D009BKS	95	E075WT	120	E513	113	E562BK	109
C952	137	CL231	56	CL712	59	D009BS	95	E075WT	80	E513H	113	E562NB	109
C953	137	CL232	56	CL715	59	D009N	94	E085BK	121	E513L	113	E562WT	109
C954	133	CL233	54	CL716	59	D009NS	95	E085CR	121	E515	113	E563BE	109
C955	133	CL233BP	54	CL802	60	D009NX	94	E085IV	121	E515H	113	E563BK	109
C956	133	CL234	59	CL803	56	D010BKS	95	E085NV	121	E515L	113	E563GY	109
C959	133	CL234W	59	CL804	57	D010BS	95	E085RB	121	E517	113	E563NB	109
C962N	72, 155	CL235	61	CL805	57	D010NS	95	E085SD	121	E517H	113	E563WT	109
C970	93, 155	CL236	61	CL814	56	D011BKS	95	E085SW	121	E517L	113	E564BK	109
C980	84, 152	CL236AN	61	CL815	56	D011BS	95	E085WT	121	E518	113	E564NB	109
C995	127	CL237	61	CL816	56	D011NS	95	E086BK	121	E518H	113	E564WT	109
C995B	127	CL238	61	CL817	56	D012BKS	95	E086WT	121	E518L	113	E565BE	109
C996/10	127	CL239	61	CL818	56	D012BS							

Part No.	Page	Part No.	Page	Part No.	Page	Part No.	Page	Part No.	Page	Part No.	Page	Part No.	Page
E585BK	108	E7050WT	111	ED025BE	116	ES030YE	119	F83500230A	79	G147	134	G620BK	123
E585BKL	108	E7050WTH	111	ED025BG	116	ES040BK	119	F83500300A	79	G148	135	G620S	123
E585GY	108	E7050WTL	111	ED025BK	116	ES040BU	119	F83500450A	79	G151	135	G620SS	123
E585NB	108	E7100BK	111	ED025CGY	116	ES040CG	119	FP072CL	160	G151SS	135	G621BK	122
E586	108	E7100BKH	111	ED025CNV	116	ES040PGY	119	FP072NB	160	G152	135	G622BK	125
E586BE	108	E7100BKL	111	ED025GR	116	ES040RD	119	FP072SB	160	G1520S	135	G622S	125
E586BK	108	E7100WT	111	ED025GY	116	ES040S	119	FWN4501A	84	G153	135	G623S	125
E586GY	108	E7100WTH	111	ED025HBE	116	ES040WT	119	FWN4510A	84	G154	135	G623SS	123
E586NB	108	E7100WTL	111	ED025LN	116	ES060WT	119	FWN4513A	84	G155	135	G624S	125
E587	108	E8020BK	112	ED025MBU	116	ESF030BE	118	FWN4550A	84	G156	135	G625LAN	126
E587BK	108	E8020BKH	112	ED025NV	116	ESF030BK	118	FWN4560A	84	G157	135	G625PIN	126
E588	110	E8020BKL	112	ED025OY	116	ESF030NV	118	FWN4599A	84	G158	135	G625S	125
E588BK	110	E8020WT	112	ED025PBU	116	ESF030WT	118	FWP0400A	79	G160ABK	137	G625SQP	125
E589	110	E8020WTH	112	ED025RD	116	ESF040BE	118	FWP0500A	79	G160AWT	137	G626S	125
E589BK	110	E8020WTL	112	ED025SP	116	ESF040BK	118	FWP0600A	79	G160BK	137	G627PIN	126
E591	110	E8025BE	112	ED025TC	116	ESF040NV	118	FWP0700A	79	G160WT	137	G629S	126
E591BK	110	E8025BEH	112	ED025TP	116	ESF040WT	118	FWP0800A	79	G161BK	137	G630SHD	123
E592	110	E8025BEL	112	ED025TST	116	ET030WT	114	FWP0900A	79	G161WT	137	G631SHD	122
E592BK	110	E8025BK	112	ED025WT	116	ET046BU	114	FWPP03100	78	G171	135	G638	131
E593	110	E8025BKH	112	ED040BE	116	ET046WT	114	FWPP03191	78	G171FW	135	G639	131
E593BK	110	E8025BKL	112	ED040BG	116	ET069BU	114	FWPP06100	78	G175	135	G640SHD	123
E594	110	E8025GY	112	ED040BK	116	ET069GY	114	FWPP06191	78	G182	135	G641SHD	122
E598WT	108	E8025GYH	112	ED040CGY	116	ET069WT	114	FWPP09100	78	G190BK	133	G650WT	124
E600WT	109	E8025GYL	112	ED040CNV	116	ET069WT1	114	FWPP09191	78	G190WT	133	G651WT	124
E601BK	107	E8025NB	112	ED040GR	116	ET092BK	114	G040BK	93	G191BK	133	G652WT	124
E601WT	107	E8025NBH	112	ED040GY	116	ET092BU	114	G040WT	93	G191WT	133	G653WT	124
E602BK	107	E8025NBL	112	ED040HBE	116	ET092GY	114	G045BK	144	G192BK	133	G655	124
E602WT	107	E8025WT	112	ED040LN	116	ET092WT	114	G045WT	144	G192WT	133	G671S	122
E605BK	108	E8025WTH	112	ED040MBU	116	ET138BK	114	G046BK	144	G194BK	133	G672S	124
E605WT	108	E8025WTL	112	ED040NV	116	ET138BU	114	G046WT	144	G194WT	133	G674S	125
E608BK	108	E8030BK	112	ED040OY	116	ET138GY	114	G048BK	130	G195CL	130	G675	122
E609WT	108	E8030BKH	112	ED040PBU	116	ET138TN	114	G050BK	130	G195WT	133	G675S	125
E610BK	110	E8030BKL	112	ED040RD	116	ET138WT	114	G050BU	130	G196CL	133	G676	122
E610WT	110	E8030WT	112	ED040SP	116	ET207BK	114	G050GY	130	G200S	102	G677S	125
E611BK	110	E8030WTH	112	ED040TC	116	ET207WT	114	G050WT	130	G203S	92, 145	G678S	122
E611WT	110	E8030WTL	112	ED040TP	116	ET346WT	114	G055BK	144	G204N	92, 145	G679	122
E612BK	110	E8038BK	112	ED040TST	116	ET353	120	G055WT	144	G210S	101	G681S	122
E612WT	110	E8038BKH	112	ED040WT	116	EVMR02143	106, 159	G100	138	G211S	101	G682S	124
E613BK	110	E8038BKL	112	EF1500CHIT	118	EVMR05200	106, 159	G101	138	G221	101	G692S	125
E613WT	110	E8038WT	112	EF1500DHT	118	EW346	120	G101FW	138	G221S	101	G697S	123
E614BK	107	E8038WTH	112	EF1500WHIT	118	EW351	120	G103	138	G222S	101	G738	131
E7020BK	111	E8038WTL	112	EF2640CHIT	118	EW352	120	G103A	138	G223	101	G742S	102
E7020BKH	111	E8050BE	112	EF2640DHT	118	EW352BK	120	G103BP	138	G308	130	G744S	124
E7020BKL	111	E8050BEH	112	EF2640WHIT	118	EW462	120	G104	138	G309	130	G747S	124
E7020WT	111	E8050BEL	112	EP225BK	98	EW499	120	G104A	138	G340BD	135	G758	124
E7020WTH	111	E8050BK	112	EP225BU	98	EW500	120	G104BP	138	G342BD	135	G820S	123
E7020WTL	111	E8050BKH	112	EP225GY	98	EY092BEG8	117	G105	138	G343BD	135	G830S	123
E7025BE	111	E8050BKL	112	EP225NB	98	EY092BG8	117	G105A	138	G345BD	135	G840S	123
E7025BEH	111	E8050GY	112	EP225NT	98	EY092BK8	117	G105FW	138	G371	130	G840SSP	123
E7025BEL	111	E8050GYH	112	EP225YE	98	EY092BRN8	117	G105MW	138	G400	136	GRFAB03	164
E7025BK	111	E8050GYL	112	EP226BK	98	EY092CNV8	117	G106	138	G403	136	GRFAB04	164
E7025BKH	111	E8050NB	112	EP226BU	98	EY092FGR8	117	G108	138	G404	136	GRFAB05	164
E7025BKL	111	E8050NBH	112	EP226GR	98	EY092GS8	117	G108BP	138	G406	136	GRFAB06	164
E7025GY	111	E8050NBL	112	EP226GY	98	EY092JRD8	117	G113	139	G406L	136	GRFAB07	164
E7025GYH	111	E8050WT	112	EP226NB	98	EY092LN8	117	G115S	139	G440	132	GRFAB13	164
E7025GYL	111	E8050WTH	112	EP226RD	98	EY092LRD8	117	G116S	139	G440BK	132	GRFAB16	164
E7025NB	111	E8050WTL	112	EP226WT	98	EY092NV8	117	G118	139	G440SS	132	GRFAB54	165
E7025NBH	111	E8100BK	112	EP226YE	98	EY092PB8	117	G119	139	G442	132	GRFAB58	165
E7025NBL	111	E8100BKH	112	EP227BK	98	EY092SR8	117	G119A	139	G442BK	132	GRFAB59	165
E7025WT	111	E8100BKL	112	EP227BU	98	EY092TS8	117	G119BP	139	G442SS	132	GRFAB61	163
E7025WTH	111	E8100WT	112	EP227GY	98	EY092WT8	117	G119FW	139	G443	132	HBA912GY	46
E7025WTL	111	E8100WTH	112	EP227NB	98	EY138BEG8	117	G120	139	G443BK	132	HBA913GY	46
E7030BK	111	E8100WTL	112	EP227RD	98	EY138BG8	117	G120A	139	G443SS	132	HBA922GY	47
E7030BKH	111	EA069WT	114	EP227WT	98	EY138BK8	117	G120BP	139	G445	132	HBA923GY	47
E7030BKL	111	EA092BK	114	EP228BK	98	EY138BR8	117	G130	139	G445BK	132	HBA932GY	47
E7030WT	111	EA092BU	114	EP228BU	98	EY138CNV8	117	G130A	139	G445SS	132	HBA933GY	47
E7030WTH	111	EA092PB	114	EP228GR	98	EY138FGR8	117	G130BP	139	G451SS	132	HBA942GY	46
E7030WTL	111	EA092WT	114	EP228NB	98	EY138GY8	117	G130LP	139	G452SS	132	HBA943GY	46
E7038BK	111	EA138BK	114	EP228RD	98	EY138L8	117	G140	134	G512	128	HBA952GY	47
E7038BKH	111	EA138WT	114	EP228WT	98	EY138LRD8	117	G140BK	134	G51201S	128	HBA953GY	47
E7038BKL	111	EB046FWT	115	EP228YE	98	EY138NV8	117	G140BKM	134	G512015BK	128	HBA962GY	47
E7038WT	111	EB046GWT	115	ES020BK	119	EY138PB8	117	G140BU	134	G512018	128	HBA963GY	47
E7038WTL	111	EB046LWT	115	ES020BU	119	EY138RD8	117	G140NV	134	G513	128	INS001BU	85
E7038WTL	111	EB069DWT	115	ES020CG	119	EY138SR8	117	G140SS	134	G520-8	128	INS007BR	85
E7050BE	111	EB069GWT	115	ES020WT	119	EY138TS8	117	G140TST	134	G535WT/95	128	INS009BU	85
E7050BEH	111	EB069LTN	115	ES030BG	119	EY138WT8	117	G140WT	134	G541WT/8	128	INS009RD	85
E7050BK	111	EB092DWT	115	ES030BK	119	F0808Z00Y	80	G141	135	G590	125	INS011RD	85
E7050BKH	111	EB092FWT	115	ES030BU	119	F0808Z18Y	80	G141SS	134	G590C	125	INS017BK	85
E7050BKL	111	EB092GWT	115	ES030CGY	119	F0808Z75Y	80	G142	134	G603	126	INS017BU	85
E7050GY	111	EB092LWT	115	ES030NV	119	F0808Z79Y	80	G142SS	134	G605S	126	INS017RD	85
E7050GYH	111	ED020BK	116	ES030PBU	119	F0808Z88Y	80	G143	135	G607S	126	INS018BK	85
E7050GYL	111	ED020CGY	116	ES030PGY	119	F0808Z90Y	80	G143SS	135	G610S	123	INS019BK	85
E7050NB	111	ED020NV	116	ES030RD	119	F0808Z97Y	80	G144	135	G611S	122	INS019BU	85
E7050NBH	111	ED020PBU	116	ES030SS	119	F7010Z00M	79	G145	134	G612S	122	INS023BK	85
E7050NBL	111	ED020WT	116	ES030WT	119	F83500100A	79	G145SS	134	G615S	125	INS023BU	85
						F83500206A	79	G146	134	G615SQP	125	INS027B/R	85

Part No.	Page	Part No.	Page	Part No.	Page	Part No.	Page	Part No.	Page	Part No.	Page	Part No.	Page
INS031BK	85	J100GR	82	KRDE03W1	89	KRST03X1	91	L204100G10	17	L405120G15	19	L408220G15	20
INS031BU	85	J100GY	82	KRDE03W2	89	KRST05W1	91	L205080G10	17	L405120G20	20	L408220G20	21
INS033BK	85	J100RD	82	KRDE04W1	89	KRST05X1	91	L205090C10	23	L405140C10	24	L408240G15	20
INS037RD	85	J100SL	82	KRDE04W2	89	KRTSWSB50	100	L205090G10	23	L405140C15	24	L408240G20	21
INS039BK	85	J100WT	82	KRDE15W2	89	KRTSWR50	100	L205100C10	23	L405140G10	18	L409120G25	21
INS041BK	85	J125WT	82	KRGLU30W5	89	KRTSWX50	100	L205100G10	23	L405140G15	19	L409120G30	22
INS041BU	85	J132	105	KRGLU35W5	89	L001200G10	16	L205120C10	23				

Part No.	Page	Part No.	Page	Part No.	Page	Part No.	Page	Part No.	Page	Part No.	Page	Part No.	Page
L00220411000	141	LW441BK	67	S40025	68	S60040F	71	S80100T20	69	T025RD	70	U00448S	10, 11
L00220802098	141	LW441BK300	67	S40025BK	68	S60050	68	S80100TN	69	T025WT	70	U00452S	10, 11
L00220902098	141	LW441WT	67	S40025BKF	70	S60050BK	69	S80120	68	T040GR	70	U00454S	10, 11
L00222005098	141	LW441WT300	67	S40025BU	70	S60050F	71	S80125	68	T040RD	70	U00462	10, 11
L00222402098	141	M010/10	165	S40025BUF	70	S60060	68	S80125CR	69	T040WT	70	U00463	10, 11
L00222602098	141	M012	165	S40025F	71	S60060F	71	S80125SP	69	T050GR	70	U00464	10, 11
L00222802098	141	M030	106, 163	S40025GR	70	S60063	68	S80125SP20	69	T050RD	70	U00466	10, 11
L00223000000	141	M031	106, 163	S40025GRF	70	S60063BK	69	S80125T	69	T050WT	70	U00468	10, 11
L00223100000	141	M032	106, 163	S40025RD	70	S60063CR	69	S80125T20	69	T060GR	70	U00472	10, 11
L00223300000	141	M040	84, 162	S40025RDF	70	S60063F	71	S80125TN	69	T060RD	70	U00474	10, 11
L00438605098	140	M150	163	S40030	68	S60063TN	69	S80150	68	T060WT	70	U00642	6, 7
L00438611000	140	M212	166	S40030BK	70	S60070	68	S80175	68	T075GR	70	U00658	8, 9
L00438679098	140	M216	163	S40040	68	S60075	68	S80200	68	T075RD	70	U00658	10, 11
L00449205000	144	M2214	166	S40040BK	70	S60075CR	69	S80250	68	T075WT	70	U01520Y	10, 11
L00449500000	144	M2224	166	S40040BU	70	S60075F	71	SC230BK	86	T080GR	70	U01530	6, 7
L00511505000	142	M305	152	S40040BUF	70	S60075TN	69	SC230BKL	86	T080RD	70	U01530	8, 9
L00511511000	142	M5110	164	S40040F	71	S60080	68	SC230BU	86	T080WT	70	U01530	10, 11
L00511525000	142	M5205	164	S40040GR	70	S60080BK	69	SC230RD	86	TT100BU	83	U01531	6, 7
L00511549000	143	M5307	163	S40040GRF	70	S60080CR	69	SC230RDL	86	TT100GR	83	U01531	8, 9
L00511569000	142	M5403	166	S40040RD	70	S60080F	71	SC230WT	86	TT100RD	83	U01531	10, 11
L00511579098	142	M5801	165	S40040RDF	70	S60080L	68	SC250BK	86	TY1016-L	40	U01532	6, 7
L00513405000	143	MYL175	80	S40045	68	S60080TN	69	SC300BK	86	TY1330	40	U01532	8, 9
L00513411000	143	MYL250	80	S40050	68	S60090	68	SC300BKL	86	TY1405	43	U01532	10, 11
L00513425000	143	MYL35003	80	S40050BK	70	S60100	68	SC300BU	86	TY1408	43	U01535	8, 9
L00513469000	143	MYL35003	160	S40050BKF	70	S60100BK	69	SC300RD	86	TY1412	43	U01535	6, 7
L00513479098	143	NC13400D090	146	S40050BU	70	S60100CR	69	SC300RDL	86	TY1420	43	U01535	10, 11
L00514005000	143	NC13400D100	146	S40050BUF	70	S60100F	71	SD002BK	83	TY1505	43	U01536	6, 7
L00514011000	143	NC13400D110	146	S40050F	71	S60100L	68	SD002BU	83	TY1508	43	U01536	8, 9
L00514025000	143	NC13400D120	146	S40050GR	70	S60100TN	69	SD002GR	83	TY1508-S	44	U01536	10, 11
L00514049000	143	NC13400D130	146	S40050GRF	70	S60120	68	SD002GY	83	TY1512	43	U01540	6, 7
L00514069000	143	NC13400R090	146	S40050RD	70	S60120F	71	SD002RD	83	TY1512-S	44	U01540	8, 9
L00514079098	143	NC13400R100	146	S40050RDF	70	S60125	68	SD002WT	83	TY1520	43	U30063	12, 25
L00514105000	143	NC13400R110	146	S40060	68	S60125F	71	SL001	87	TY1605	41	U30076	12, 25
L00514111000	143	NC13400R120	146	S40060BK	70	S60125L	68	SL002BK	83	TY1606	41	U30102	12, 25
L00514125000	143	NC13400R130	146	S40060BU	70	S60150	68	SL002BU	83	TY1616	41	U30114	12, 25
L00514149000	143	NC13400R140	146	S40060F	71	S60200	68	SL002GR	83	TY1640	41	U30127	12, 25
L00514169000	143	NC13435D090	146	S40060GR	70	S60230	68	SL002GY	83	TY1808	41	UBGD1014	44
L00514179098	143	NC13435D100	146	S40060RD	70	S60250	68	SL002RD	83	TY1812	41	UBGD812	44
L00514205000	142	NC13435D110	146	S40063	68	S60300	68	SL002WT	83	TY1820	41	UBPD36	44
L00514211000	142	NC13435D120	146	S40063BK	70	S70050	68	SL003BK	83	TY1820-SS	41	UBPD46	44
L00514279098	142	NC13435D130	146	S40063F	71	S70060	68	SL003BU	83	TY1830-SS	41	UBPD50	44
L00515163000	142	NC13435R090	147	S40070	68	S70060F	71	SL003GR	83	TY1908	41	UBPS100PM12	14
L00515263000	142	NC13435R100	147	S40075	68	S70063	68	SL003GY	83	TY1912	41	UBPS100PM14	14
L00518011000	142	NC13435R110	147	S40075BK	70	S70070	68	SL003RD	83	TY1920	41	UBPS100PM16	14
L005565805000	142	NC13435R120	147	S40075BU	70	S70070F	71	SL003WT	83	TY2506	45	UBPS100PNM12	13
L005565879098	142	NC13435R130	147	S40075GR	70	S70075	68	SL004BK	83	TY2506-SS	45	UBPS100PNM14	13
L005592905000	144	NC13517R090	147	S40075RD	70	S70075BK	69	SL004BU	83	TY2508	45	UBPS100PNM16	13
L005592911000	144	NC13517R100	147	S40080	68	S70075CR	69	SL004GR	83	TY2508-SS	45	UBPS40PM10	13
L005592949000	144	NC13517R110	147	S40080BK	70	S70075TN	69	SL004GY	83	TY2510	45	UBPS50M10	14
L005592979098	144	NC13517R120	147	S40080BU	70	S700795	68	SL004RD	83	TY2510-SS	45	UBPS50M12	14
L005593005000	144	NC13517R130	147	S40080F	71	S70080	68	SL004WT	83	TY2512	45	UBPS70NM10	13
L005593011000	144	NC79400R140	147	S40080RD	70	S70080CR	69	SL006BK	83	TY2512-SS	45	UBPS70NM12	13
L005593105098	140	NC79400R160	147	S40100	68	S70080F	71	SL006BU	83	TY2514	45	UBPS70NM14	13
L005593111000	140	NC79400R180	147	S40100BK	70	S70080TN	69	SL006GR	83	TY2514-SS	45	UBPS70PM10	14
L005593179098	140	NC79400R200	147	S40100BKF	70	S70090	68	SL006GY	83	TY2516	45	UBPS70PM12	14
L00559402098	144	NC79400R230	147	S40100BU	70	S70095	68	SL006RD	83	TY2516-SS	45	UBPS70PNM10	13
L00559502098	144	NC79400R250	147	S40100BUF	70	S70100	68	SL006WT	83	TY2518	45	UBPS70PNM12	13
L00673679098	142	NG13400R100	148	S40100GRF	70	S70100BK	69	SL230	87	TY2518-SS	45	UBPS70PNM14	13
L00673779098	142	NG13400R120	148	S40100RD	70	S70100CR	69	SL250	87	TY2524-SS	45	UBPS70T20M10	13
L00719005098	140	NG13435R100	148	S40100RDF	70	S70100F	71	SL300	87	TYJ12	40	UBPS70T20M12	13
L00719011000	140	NG13435R120	148	S40125	68	S70100L	68	SL380	87	TYJ20	40	UBPS70T24M10	13
L00719079098	140	NG13517R110	148	S40125BK	70	S70100TN	69	SL450	87	TYJ8	40	UBPS70T24M12	13
L00800305098	140	NG13517R130	148	S40150	68	S70120	68	SN001	86	TYT12	39	V006BK	87
L00800311000	140	OLFBNAL	156	S440040BKF	70	S70120F	71	SN100	86	TYT12L	40	V006BR	87
L00800379098	140	OLFDC2	157	S50025	68	S70125	68	SN150	86	TYT16	39	V006BU	87
L00831205000	142	OLFLB10	156	S50040	68	S70125BK	69	SN230	86	TYT20	39	V006DG	87
L00831211000	142	OLFLB10B	156	S50050	68	S70125CR	69	SN250	86	TYT20L	40	V006GR	87
L00831279098	142	OLFLBB10B	156	S50050F	71	S70125F	71	SN300	86	TYT30	39	V006GY	87
L00885900000	140	OLFLBB50B	156	S50050TN	69	S70125L	68	SN380	86	TYT30L	40	V006NB	87
L00886502098	143	OLFLFB5B	157	S50060	68	S70125TN	69	SN450	86	TYT5	39	V006RD	87
L00889102098	143	OLFLWB3B	157	S50060F	71	S70150	68	SPR3522500155	37	TYT5L	40	V006WT	87
L09512105000	144	OLFMXPAL	156	S50063	68	S70175	68	SPR3532060055	37	TYT8	39	V006YE	87
L09512111000	144	OLFRB2810	157	S50063F	71	S70250	68	SPR35420016A0	37	TYT8L	40	ZMARKERWT	161
L09512125000	144	OLFRB282	157	S50063TN	69	S80040	68	SPR3605004533	42	U00322	10, 11	ZPENCILBU	161
L09512149000	144	RO04070000240	162	S50070	68	S80050	68	SPR3605006033	42	U00341S	8, 9	ZPENCILW2	161
L09512169000	144	RO14481000240	162	S50075	68	S80060	68	SPR3605303556	42	U00343S	8, 9		
LR001025	67	RO15260001	152	S50080	68	S80063	68	SPR3605305056	42	U00345S	8, 9		
LS401BG	131	RO15260005	152	S50080F	71	S80070	68	SPR3605307056	42	U00357S	8, 9		
LS401BK	131	RO640400004	162	S50080L	68	S80075	68	SPR3605309556	42	U00361	8, 9		
LS401BU	131	RO64070000400	162	S50090	68	S80080	68	SPR3605407056	42	U00363	8, 9		
LS401GY	131	RSESC03WRD	92	S50090F	71	S80080T	69	SPR3605409056	42	U00365	8, 9		
LS401TN	131	RSESC04WRD	92	S50100	68	S80080T20	69	SPR3605412056	42	U00377	8, 9		
LU605	67	RSESC05WRD	92	S50100F	71	S80090	68	SPR3605507056	42	U00442S	10, 11		
LU606	67	RSESC06WRD	92	S50125	68	S80100	68	SPR3605509056	42	U00443S	10, 11		
LU607	67	RSESC08WRD	92	S50350	68	S80100CR	69	SPR3605513056	42	U00444S	10, 11		
LU608	67	S40020	68	S60040	68	S80100T	69	T025GR	70	U00446S	10, 11		

Product	Page	Product	Page
3 Strand Polyester Rope	88, 91	Canopy Deck Fittings	125
303 Protectant	165	Canopy Deck Hinges	125
3M Adhesive Remover	84, 162	Canopy Eye Ends	122
3M Tape	105	Canopy Hand Clamps	124

Product	Page	Product	Page
Elastic Shockcord	92	Insignia Tapes	82
End Fittings.....	29	Insignia Tell Tale Patches	83
End Plugs.....	122	Jacket Zips	108, 109, 110
Engel Hot Knife	153	Jackstay Life Lines	100
English Grommet Closing Tools	94	Jackstay Webbing	100
English Grommets	94	Jaw Slides	123
Extruded Vinyl Rope.....	88	Keder Sprayhood Tapes.....	129
Eye Ends.....	122	Keder Track.....	128
Eye Straps	92, 145	Keder Track Slides.....	129
Fabric Protector.....	164, 165	Kevlar® Shears	154
Fabsil	163, 164, 165	Kevlar® Webbing.....	99
Fabsil Gear Cleaner	165	Kiwi Slides.....	32
Fasteners	132, 133, 134, 135, 136, 137, 138, 139, 140, 141 142, 143, 144	Knee Pads	161
Fids.....	41	Knife Blades.....	156, 157
Fiskars Scissors.....	154	Knives	156, 157, 159
Flex-A-Rail Awning Track.....	128	Lacing Buttons.....	144
Folded Sailcloth Tape.....	70, 71	Ladderlock Buckles	101
Furling Rope	90	Laser Class Computer Eights.....	87
Glass Cleaner.....	166	Leather.....	158
Glass Protector	166	Leather & Vinyl Protector.....	165
Gransegel Cleats	53	Leechline.....	89, 90
Grommets	94, 95	Leechline Cleats	53, 54, 55
Groz-Beckert® Sewing Machine Needles	146, 147, 148	Left Handed Palms	151
GRP Deck Cleaner	166	Lift-the-DOT® Fasteners	139
Halyard Lines.....	90	Locking Shockcord Hooks	93
Halyard Shackles	43, 44	Lofting Battens	160
Hammers	160	Low Friction Rings	53
Hand Sewing Needles.....	149	LOXX Fasteners	140, 141, 142, 143, 144
Hand Sewing Thread	120	Lubricating Grease	162
Hanks	35, 36	Luff Boxes	6, 8, 10, 13, 14
Hard Braid Luffline	89	Luff Foam.....	67
Headboard Liners	47, 49, 52	Luff Tape	64, 65, 66, 67
Headboards.....	46, 47, 50, 51	Luffline	89
Heminway & Bartlett Thread.....	114, 115	Mallets	160
High Tack Polyester Insignia	81	Marking Pencils.....	161
Holdon® Clips.....	145	Marking Tools	161
Hole Punches.....	94, 97, 159	Matte Black Grommets	95
Hook & Loop	111, 112, 113	Maul Master	160
Hot Knife Blades	153	Maxi Rings.....	77
Hot Knives	153	Measuring Battens	161
Hot Tool Blades.....	153	Measuring Tools.....	161
Hot Tools	153	Metal Polish & Restorer	166
Hull Cleaner.....	165	Mildew Remover	166
IMAR Staraglass	166	Mould & Mildew Remover	166
Inox Outhaul Attachments	75	Mylar®/Kevlar® Tape.....	105
Inox Pressed Rings	74	Needles	146, 147, 148, 149, 150
Inox Pressed Rings Closing Tools.....	75	Nickel Plated Grommets	94, 95
Insignia.....	81	Nickel Plated Sailmakers Needles	149
Insignia Circles	83	Nicopress Tool	72, 155
Insignia Draft Stripe.....	82	Nicopress Sleeves	72
Insignia Sail Letters	87	Nylon Repair Tape.....	84
Insignia Sail Numbers	86	Nylon Spinnaker Tape.....	70
		Nylon Webbing	99

Product	Page	Product	Page
OLFA® Knives & Blades	156, 157	Sail Rings	77
Outhaul Attachments.....	75	Sail ties	100
Patch Cloth.....	78, 79, 80	Sailcloth Tape.....	68, 69, 70, 71, 84
Patching Leather	158	Sailmakers Leather	158
Pattern Material.....	160	Sailmakers Needles	149
Pencils.....	161	Sailmakers Palms.....	151
Permalock Fasteners	137	Sailman 3000	6, 7
Plastic Awning Track	128	Sailman 3500	8, 9
Pliers	93, 155	Sailman 4000	10, 11
Pocket Protectors	28	Sailman Rings.....	73
Polish & Wax.....	166	Sailman X Clewboards	48, 49
Polyester Film.....	80	Sailman X Headboards	46, 47
Polyester Insignia	81	Saliman Rings Closing Tools	73
Polyester Leechline	90	Scissor Sharpener	154
Polyester Luffline.....	89	Scissors.....	154
Polyester Monofilm.....	80	SDA Fittings	30
Polyester PSA	80	Seam Kote 4.....	163
Polyester Ropes	88	Seam Rollers	106, 159
Polyester Sailcloth Tape	68, 69, 70, 71	Seam Sealer.....	163
Polyester Sailcloth with PSA.....	79	Seaming & Bonding Tapes.....	104, 105
Polyester Webbing	98, 99	Seaming Palms.....	151
Polynite Boltropes.....	88	Seaming Tape.....	104, 105
Polypropylene Bolt Rope.....	88	Seaming Tools.....	106, 159
Polypropylene Self-reinforced Composite Material.....	78	Seatbelt Webbing	100
Polypropylene Webbing.....	98	Self-Adhesive Hook & Loop.....	112, 113
Pressed Rings.....	74	Separating Jaw Slides	123
Pre-stretched Polyester Rope	91	Serabond Thread	119
Printable Polyester Insignia	81	Serafil Thread	118
Protectants.....	162, 163, 164, 165, 166	Sew on Cover Eyelets.....	92, 145
PSA Monofilm	80	Sew on Cover Hooks	92, 145
PSA Patching	79	Sew on Fairlead Eyelets	145
PTFE Tape	69	Sewing Machine Needles	146, 147, 148
PTFE Thread	118	Sewing Machine Oil.....	152
Punches	94, 97, 159	Sewing Palms	151
Pure® Sheets.....	78	Sew-on Hook & Loop	111, 113
Pushpins	158	Shackles.....	6, 29, 34, 35
Rawhide Mallets	160	Shears	154, 155
Reef Blocks	38	Shockcord	92
Reinforced Webbing.....	99	Shockcord Accessories.....	92, 93, 144, 145
Repair Kits	84, 152	Shockcord Clamps.....	93
Revolving Hand Punches	159	Shockcord Cover Clips.....	93
Right Handed Palms	151	Shockcord Hooks	93
Rings	76	Shockcord Lock.....	93
Rivets.....	53	Silicone Protector	162
Rock Oil.....	152, 162	Slide Tracks	125
Rope	88, 89, 90, 91	Sliding Bar Buckles	101
Roping Palms.....	151	Slug Slides	32, 33
Rotary Cutter Blades	157	Snap Buckles	101
Ruler.....	161	Snap Eye Bolts	102
Sail Cleaner	163	Snap Fasteners	132, 133, 134, 135
Sail Letters.....	87	Snap Hooks	36, 37, 102
Sail Numbers	86	Snap Hooks for Webbing.....	102
Sail Repair Patches.....	99	Snap Shackles	39, 40, 42



Product	Page	Product	Page
Snap-off Knife Blades.....	156, 157	Track Slides	6, 31, 32, 33
Solacryl Acrylic Binding	121	Tri-Ring for Webbing.....	102
Solacryl PSA.....	79	Tube Benders	127
SolarFix® Thread.....	118	Tubular Webbing.....	99
Speedy Stitcher	150	Turnbutton Fasteners	136, 137, 138, 139
Spray Adhesive.....	162	Universal Deck Mount.....	126
Spray Welt.....	129	Untapered Battens	12, 16, 23, 25, 26
Sprayhood Tapes.....	129	Utility Tape	104
Stainless Steel Boat Top Fittings.....	122, 123, 124	UVR Thread	116
Stainless Steel D Rings.....	76	Velcro® Hook & Loop.....	113
Stainless Steel Grommets	94	Vents.....	130
Stainless Steel Rings	76	Vinyl Bias Binding	120
Stainless Steel Screws	126, 128	Water Resistant Grease	162
Stainless Steel Thimbles	72	Waterproof Seal	129
Stainless Steel Triangles	76	Wax.....	120, 166
Stamoid® Vinyl Binding.....	121	Waxed Lacing Tape	120
Staplers	158	Waxed Sewing Thread.....	120
Staples	158	Webbing	98, 99, 100
Stimpson Grommets.....	95	Webbing Bridges.....	102
Stimpson Modular Closing Tools.....	96, 97	Webbing Fittings	101
Stitchers.....	150	Welded Luff Tape	67
Stitching Awl	150	White Spray Grease	162
Sun Sox	131	Window Protectors.....	131
Sunblocker Clips.....	131	Wire Cutters.....	93, 155
SunStop Anti-Wick Thread.....	117	Wiss Shears	155
Super Seal.....	129	Yacht Headboards	50
SuperLuff	64, 65, 66, 67	YKK® Continuous Coil.....	110
Tack Shackles	36	YKK® Continuous Vislon®.....	107
Tape.....	104, 105	YKK® SNAD® Fasteners	133
Tape Measure.....	161	YKK® Vislon®	107, 108, 109, 110
Tell Tale Windows	80	YKK® Vislon® Jacket Zip.....	108, 109, 110
Tell Tales	83	YKK® Zippy Cool.....	106, 163
Thimbles	72	Zip End Stops	107, 110
Thread	114, 115, 116, 117, 118, 119, 120	Zip Lubricant	106, 163
Thread Lubricant	152	Zip Sliders.....	107, 108, 110
Thread Snips	154	Zips.....	107, 108, 109, 110
Titanium Low Friction Rings.....	53		
Track Fixings	128		



Bainbridge

GLOBAL HEADQUARTERS

Bainbridge International Ltd

8 Flanders Park, Southampton, Hampshire SO30 2FZ UK

T: +44 (0) 1489 776010

E: info@bainbridgeint.co.uk W: bainbridgeint.com

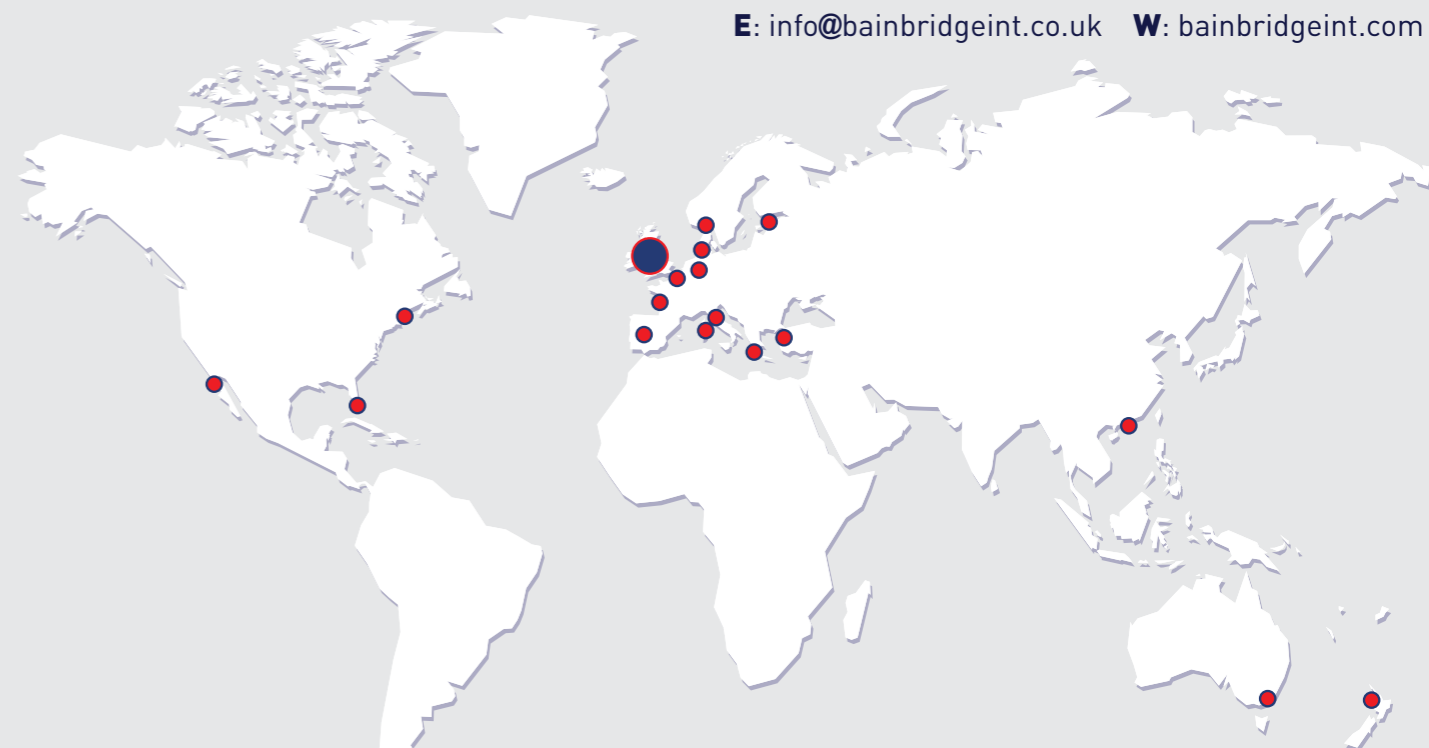

AUSTRALIA

Bainbridge International Pty. Ltd

273 Harbour Road, Brookvale, NSW 2100

T: +61 (0) 2 9938 1788

E: info@bainbridgeint.com.au

W: www.bainbridgeaus.com.au

DENMARK

Columbus Marine

Svejsegangen 3, DK-2690, Karlslunde

T: +45 4619 1166

E: info@columbus-marine.dk

W: www.columbus-marine.dk

FRANCE, SPAIN & NORTH AFRICA

VMG Soromap

Z.A. de Béligon, 17300 Rochefort / Mer, France

T: +33 (0) 5 46 87 84 80

E: contact@vmgsoromap.com

W: www.vmgisoromap.com

GERMANY

Herman Gotthardt GmbH

Leunastrasse 50, D-22761 Hamburg

T: +49 40 85150550

E: info@gotthardt-yacht.de

W: www.gotthardt-yacht.de

GREECE

Takis Kokkotas Co. Ltd.

80 Mezonos Str, 104 38, Athens

T: +30 210 52 28 540

E: info@kokkotas.gr

W: www.kokkotas.gr

HONG KONG & CHINA

Sky International

Room 703, 7/F, Henan Building, 90 Jaffe Road, Wanchai

T: +852 2827 5876

E: web@sky-international.com

W: www.sky-international.com

ITALY

Sacloma S.a.s.

Via Cisa Sud 125, 19037, S. Stefano di Magra (SP)

T: +39 0187 630603

E: sacloma@sacloma.com

W: www.sacloma.com

ITALY

Boat Rigging s.r.l.

Via San Gallo 23, 50028, Tavarnelle Val di Pesa Loc., Sambuca(FI)

T: +39 055 8071964

E: luca@boatrigging.it

W: www.boatrigging.it

NETHERLANDS

On Deck BV

Leimuiderdijk 478A, 2156 MX Weteringburg, Netherlands

T: +31 71 331 33 66

E: allhands@on-deck.nl

W: www.on-deck.nl

NEW ZEALAND

Q C D Limited

8 Taylors Road, Sandringham, 1025, Auckland

T: +64 (0) 9 815 7500

E: sales@qcd.co.nz

W: www.qcd.co.nz

RUSSIA

Fordewind-Regatta Ltd

Petrovskaya Kosa 7, 197110, St. Petersburg

T: +7 812 327 4580

E: office@fordewind-regatta.ru

W: www.fordewind-regatta.ru

SWEDEN & NORWAY

Aspero Handels AB

PO Box 5009, Traneredsvagen 112, SE-426 05 V. Frolunda

T: +46 31 299 190

E: info@aspero.se

W: www.aspero.se

TURKEY

SORG Yelken Promosyon ve

Acibadem Mh. Umut Sk. Akpak Apt. 10/A Kadikoy - Istanbul

T: +90 (216) 3177575

E: info@sailmaker.org

W: www.sailmaker.org

USA, CANADA, SOUTH AMERICA & CARIBBEAN

Bainbridge International Inc.

255 Revere Street, Canton 02021, Massachusetts

T: +1 781 821 2600

E: info@bainbridgeintusa.com

W: www.bainbridgeintusa.com



Bainbridge

Bainbridge International Ltd

8 Flanders Park, Southampton, Hampshire SO30 2FZ UK

T: +44 (0) 1489 776010

E: info@bainbridgeint.co.uk

W: bainbridgeint.com